



# MAIN UKRAINIAN MILITARY PRODUCTS AND SERVICES

BRIEF CATALOGUE 2025





# SPETSTECHNOEXPORT (STE)

- Spetstechnoexport is an authorized state intermediary for the implementation of foreign economic activity in the field of export and import of products and services for military and special purposes
- STE is also one of the state-owned enterprises that perform the State Defense Order

- Expert in export and import of products and services of the Defense industry, innovation development, establishment of defense and technical cooperation with partner countries and companies
- 26 years of experience in the world defense market

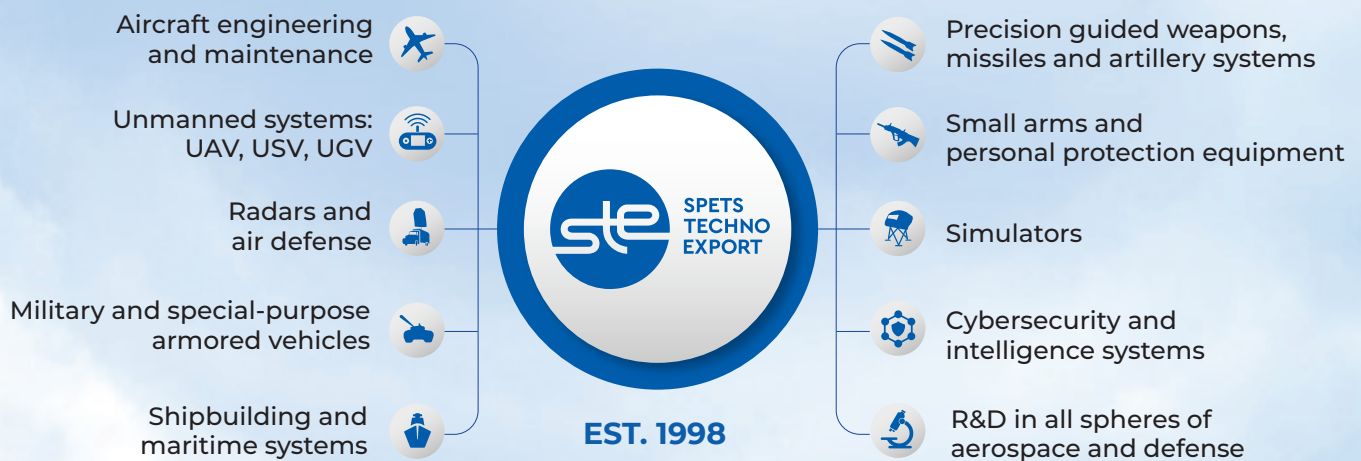

## BUSINESS PROFILE

EXPORT AND IMPORT OF PRODUCTS AND SERVICES



MODERNIZATION, REPAIR AND MAINTENANCE OF SPECIAL AND MILITARY EQUIPMENT



INVESTMENT IN HIGH-TECH DEVELOPMENTS



MARKETING AND INFORMATION CONSULTING ACTIVITIES



















TECHNOLOGY TRANSFER AND JOINT PRODUCTION



LOCALIZATION OF MANUFACTURING



## TABLE OF CONTENTS

	<b>ARMORED VEHICLES</b> ..... 4 – 9
	BTR-4
	BTR 3
	VARTA
	NOVATOR
	<b>MILITARY AND SPECIAL PURPOSE VEHICLES</b> ..... 10 – 11
	GPM-72
	LEV
	MODERNIZATION OF ARMORED VEHICLES
	<b>ARMOR PROTECTION SYSTEMS</b> ..... 11
	NIZH-L
	<b>REMOTE CONTROLLED WEAPON STATIONS</b> ..... 12
	<b>ARTILLERY</b> ..... 13
	BM-21U VERBA
	BM-21UM BEREST
	<b>ROCKET AND MISSILE SYSTEMS</b> ..... 14 – 15
	NEPTUNE
	<b>MISSILES AND ROCKETS MODERNIZATION</b> ..... 16 – 17
	R-27 · RS-80
	<b>PRODUCTS AND SERVICES PRESENTED BY STE AT IDEX 2025</b> ..... 18 – 57
	MURAKHA ..... 20
	DRONESQUAD FURY PRO ..... 21
	LORD D · HORNET · RUTA ..... 22 – 24
	BLITZ ..... 25
	CHAKLUN ..... 26 – 27
	CHAKLUN-B ..... 28 – 29
	CHAKLUN-B 2.0 ..... 30 – 31
	CHAKLUN-K ..... 32 – 33
	INTERCEPTOR ..... 34 – 35
	ANTI-UAV ..... 36
	PHOTON ..... 37
	BEAVER 1-20 ..... 38
	J.E.T. ..... 39
	AMUNITION FOR DRONES ..... 40 – 41
	NEBOKRAY AO 1.0, AOS 1.2 ..... 42
	ANTI-SKID ..... 43
	OCHI-1 / T1 ..... 44 – 45
	ATN TGP-7UA 320 ..... 46
	THERMAL IMAGING SCOPE ..... 47
	ATA GEAR ..... 48
	CANINE BEHAVIORAL SERVICE ..... 49
	KOZAK-2 / 2M · KOZAK-5 / 5PML · OTAMAN 6X6 · HORUNGY ..... 50 – 55
	PILOT P4, P4.5, P5, P6, P6.5, P7, P8, P10, P12 ..... 56 – 57
	TRIDENT T8/T12 ..... 58
	HD460M ..... 59
	VERSIBIONICS ..... 60
	KHARKIV 95 ..... 61
	KYIV 50 ..... 62
	ODESA 90 ..... 63
	<b>AUTOMATIC CONTROL SYSTEMS</b> ..... 64
	GURT-M

# TABLE OF CONTENTS

	<b>ANTI-UAV</b> ..... <b>65 – 67</b>
	EDM4S · SKYWIPER · OMNI NOTA
	<b>RADARS</b> ..... <b>68 – 78</b>
	KOLCHUGA RDF-360 · KOLCHUGA SDT-360
	RPS-7 INHUL
	90K6E
	BISKVIT-KB
	MINERAL-ME
	P-12, P-14, P-18, P-19, P-37 MODERNIZATION
	DELTA
ROSA	
36D6-M2	
PRV-16MA	
ASR-23L	
<b>COMINT SYSTEMS</b> ..... <b>79</b>	
KHORTYTSIA-M	
	<b>ELECTRONIC WARFARE</b> ..... <b>80 – 81</b>
	<b>CYBERSECURITY TRAINING PROGRAMS</b> ..... <b>82</b>
	CYBER & NETWORK SECURITY
ELECTRONIC WARFARE	
	<b>UNMANNED SYSTEMS</b> ..... <b>83 – 93</b>
	CICONIA
	GOR
	RAYBIRD-3
	CETUS
	OBSERVER-S
	NEMESIS
	PUNISHER · REX
	RAM II
FP-1	
MAGURA V5	
	<b>NAVAL RADARS AND FIRECONTROL EQUIPMENT</b> ..... <b>94</b>
	SENS-2
	<b>SONAR COMPLEXES AND SYSTEMS</b> ..... <b>95</b>
TRONKA-MK	
OLYMP-3K	
	<b>MODERNIZATION OF AIR DEFENSE SYSTEMS</b> ..... <b>96 – 97</b>
	ZSU-23-4 SHILKA
	2K22 TUNGUSKA
	2K12M1-2L KVADRAT-2L
	S-125M COMPLEX OVERALL UPGRADING
<b>HELICOPTERS</b> ..... <b>98 – 99</b>	
SL-231 SCOUT	
2MSB-V	
8MSB	
HELICOPTERS MODERNIZATION	
<b>AIRCRAFT MODERNIZATION</b> ..... <b>100 – 101</b>	
MIG-29 · SU-27	
AN-26 · AN-32 · AN-32 P	
	<b>LIGHT WEAPONS</b> ..... <b>102</b>
	UAG-40
<b>SMALL ARMS</b> ..... <b>103 – 104</b>	
UAR-10 / UAR-15	
VULCAN (MALYUK)	
7.62X51 LMG	
Z-008 GEN III PRECISION	
	<b>SIMULATORS</b> ..... <b>106 – 107</b>

## ARMORED VEHICLES

### BTR-4

#### ARMORED PERSONNEL CARRIER / INFANTRY FIGHTING VEHICLE

The BTR-4 armored personnel carrier is designed for the transportation of infantry unit personnel and combat fire support in various conditions, including the NBC environment

Equipped with Deutz engine and Allison transmission. Turbocharged 6-cylinder 11.9-liter diesel engine BF 6 M 1015 CP has 515 hp output at maximum rpm of 1800

The engine compartment space allows the optional installation of more powerful engines

BTR-4 is equipped with remote control weapon station (RCWS) BM-7 PARUS. A number of different RCWS are available for installation, depending on the customer's requirements



### FAMILY OF VEHICLES



**4-MV** — INFANTRY FIGHTING VEHICLE



**4K** — COMMAND VEHICLE



**4-S** — MEDICAL VEHICLE



**4RM** — REPAIR AND RECOVERY VEHICLE



**4KSH** — COMMAND AND CONTROL VEHICLE

**ENGINE**

Deutz BF6M1015CP  
four-stroke diesel, up to 515 hp

**TRANSMISSION**

ALLISON 4500SP, automatic

**MAXIMUM SPEED**

100 km/h

**BALLISTIC PROTECTION**

STANAG level 2, up to level 4

**WEIGHT**

from 17,5 t to 21,5 t  
with additional protection

**DIMENSIONS**

7650 X 2900 X 2860 mm

**CREW**

3

**TROOPERS**

7-9

**BM-7 PARUS RCWS****ARMAMENT****TYPE****CALIBER**

ARMAMENT	TYPE	CALIBER
<b>MAIN GUN</b>	ZTM-1	30 mm
<b>COAXIAL MACHINE GUN</b>	KT-7.62	7.62 mm
<b>ANTITANK MISSILE COMPLEX (ATGM)</b>	Barrier/Skif	130/152 mm
<b>GRENADE LAUNCHER</b>	KBA-117 (AG-17)	30 mm
<b>MAXIMUM TARGET DEFEATING RANGE</b>	5000 m	



The APC can be used as a basic vehicle for equipping quick-reaction forces and marine units. The APC can fulfill its tasks day-and-night, under various climatic conditions, on hard-surface roads and off-road. The operating temperature range of the APC is from -40 to +55°C

**AVAILABLE ADVANCED AMPHIBIOUS OPTION****ADDITIONAL PROTECTION**

- Against fragments of large-caliber projectiles
- Active protection system ZASLON + ERA



## BTR-3

### ARMORED PERSONNEL CARRIER / INFANTRY FIGHTING VEHICLE

The BTR-3 Armored Personnel Carrier (APC) is intended to transport mechanized infantry units and to provide fire support in combat operations. It can be used as a basic vehicle for equipping quick-reaction forces and marine units

The APC can operate day-and-night, under various climatic conditions, on hard-surface roads, off-road, and in the NBC environment



## FAMILY OF VEHICLES



**3M2** — 120-MM SELF PROPELLED MORTAR



**3RK** — COMBAT VEHICLE WITH ATGM SYSTEMS



**3S** — ARMORED MEDICAL VEHICLE



**3BR** — REPAIR AND RECOVERY VEHICLE



**3DA** — ARMORED PERSONNEL CARRIER



**ENGINE**

MTU 6R106TD21, 326 hp

**TRANSMISSION**

ALLISON 4500SP, automatic

**MAXIMUM SPEED**

100 km/h

**MAXIMUM RANGE**

600 km

**WEIGHT**

16 t

**DIMENSIONS**

7850 x 2900 x 2774 mm

**CREW**

3

**TROOPERS**

10

**SHTURM-M RCWS****ARMAMENT****TYPE****CALIBER****AUTOMATIC GUN**

ZTM-1

30 mm

**COAXIAL MACHINE GUN**

KT-7.62

7.62 mm

**ANTITANK MISSILE COMPLEX (ATGM)**

Barrier/Skif

130/152 mm

**GRENADE LAUNCHER**

KBA-117 (AG-17)

30 mm

**MAXIMUM TARGET DEFEATING RANGE**

5000 m

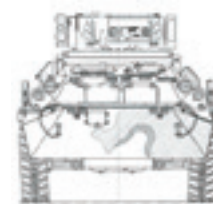
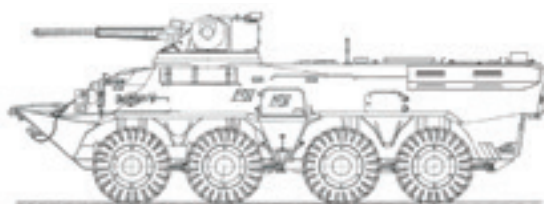

- Crew is accommodated in the airtight and waterproof cabin which protects them against nuclear radiation, chemical, and biological effects
- Design of the armored hull and chassis provides a high-level protection against explosions
- 8 firing ports for troops

**AVAILABLE ADVANCED AMPHIBIOUS OPTIONS**

Airtight and waterproof armored hull is the basis of the vehicle structure. The hull is made of armor steel and is reinforced with Kevlar from inside. The hull protects against 7.62 mm bullets and can be improved up to the level resisting to 12.7 mm bullets

**AUXILIARY EQUIPMENT**

- Winch pull power — 6 t
- Automatic firefighting system
- Filtration unit with full-flow filter
- Heater with efficiency 18 kW
- Air conditioner with cooling efficiency 10 kW

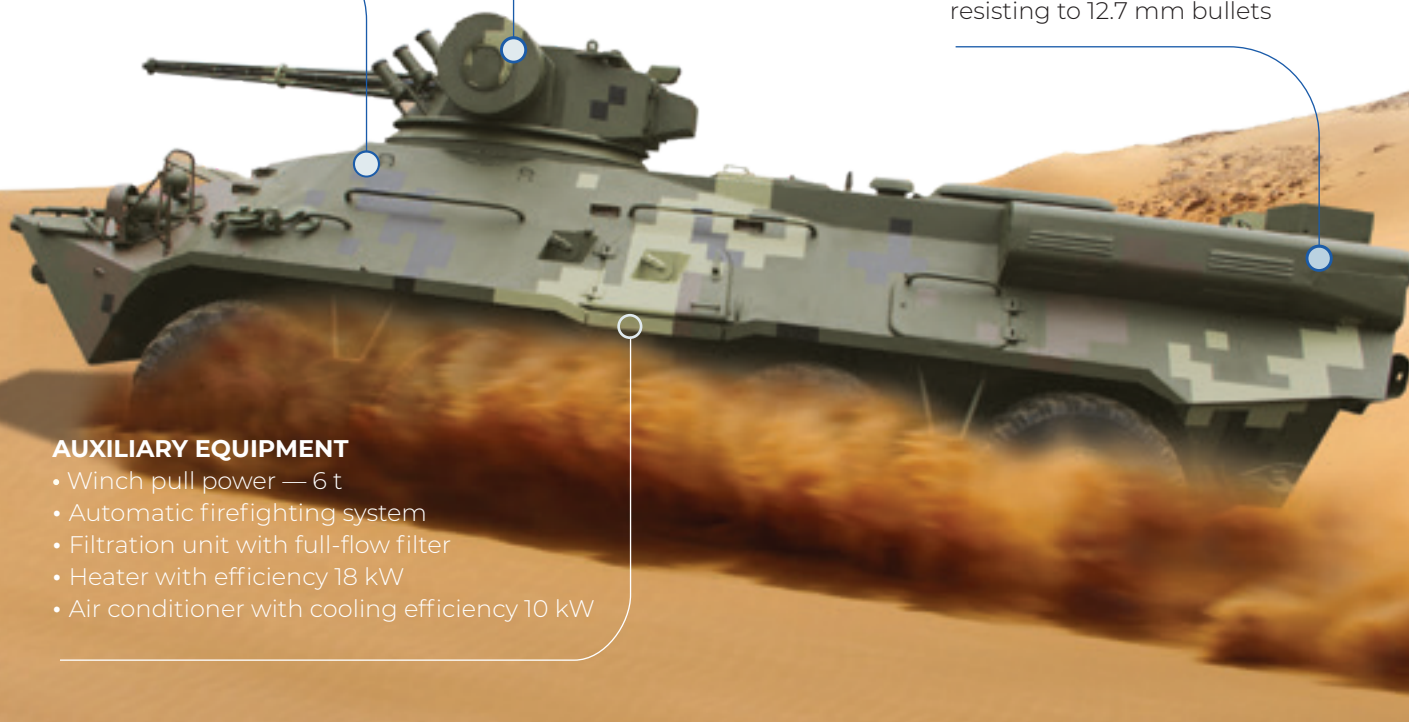

# VARTA

## ARMORED PERSONNEL CARRIER

VARTA is an armored personnel carrier (APC). It is ideal for transporting soldiers in combat situations and also can be equipped as a Command Vehicle, or vehicle for evacuating troops

The vehicle compartment is made from specialized 560-grade steel that protects the crew from armor-piercing incendiary ammo up to 7.62 mm. VARTA uses a V-shape hull structure to accommodate anti-mine seats, giving crew members protection to withstand the detonation of charges up to 6 kg of TNT

VARTA includes a combat module equipped with either the 7.62 mm or the 12.7 mm machine gun. The vehicle has ten gun ports around with the feasibility of accommodating a UBGL



**ENGINE**

V6 TD, 270-300 hp



**MAXIMUM SPEED**

120 km/h on road



**MAXIMUM RANGE**

1250 km



**WHEEL ARRANGEMENT**

4 x 4 (all-terrain chassis)



**BALLISTIC PROTECTION**

STANAG 4569 level 2, and mine blast 6 kg TNT



**MINE PROTECTION**

STANAG 4569 Level 2ab



**WEIGHT**

16,65 t



**DIMENSIONS**

6900 X 2550 X 2800 mm



**CREW**

2 + 8 + gunner





# NOVATOR

## ARMORED PERSONNEL CARRIER

NOVATOR armored vehicle is based on a redesigned and ruggedized Ford F550 chassis. It accommodates five soldiers within a cabin and has enough open-topped beds that can be configured for customer requirements

### APPLICATION

Transportation of soldiers

Command vehicle

Evacuation of troops



### ENGINE

TD, 6,7 l, 300 hp



### TORQUE

895 N\*m



### TRANSMISSION

6 TorqShift automatic



### MAXIMUM SPEED

120 km/h



### BALLISTIC PROTECTION

STANAG 4569 Level 1



### MINE PROTECTION

STANAG 4569 Level 1ab



### WEIGHT

8845 kg



### DIMENSIONS

6400 x 2385 x 2350 mm



### CREW

2 + 3



## MILITARY AND SPECIAL PURPOSE VEHICLES

### GPM-72

#### FIRE FIGHTING HEAVY VEHICLE

Designed for different classes of firefighting using water or foam, transportation of fire brigades to the place of fire, firefighting-technical equipment, and carrying out rescue operations on arsenals, bases, ammunition depots, and oil wells, clearing passages to the place of fire



### LEV

#### ARMORED REPAIR AND RECOVERY VEHICLE

Designed for mechanical support on the battlefield, assisting with the emergency evacuation of tanks from the enemy war zone by pulling tanks that have become stuck or sunken. It is also capable of carrying, lifting, performing digging and welding works, and providing technical assistance to armed units in the field





## MODERNIZATION OF ARMORED VEHICLES

### MODERNIZATION AND SPARE PARTS SUPPLY FOR ALL SOVIET-ORIGIN ARMORED VEHICLES:

- **MBTs:** T-55, T-64, T-72, T-80 etc.
- **APCs:** BTR-50, 60, 70, 80
- **IFVs:** BMP-I, BMP-II, BRDM etc.

### MODERNIZATION OF POWERPACKS WITH THE INCREASED HP — UP TO 1500 HP FOR:

- T-72
- T-80
- T-84
- T-90
- T-55
- M60 tanks

### SUPPLY OF ACTIVE AND REACTIVE ARMOR PROTECTION SYSTEMS:

- NIZH
- ZASLON
- Duplet
- Range finder and jammer F3 Phantom installation on tanks and APCs



## NIZH-L

### DYNAMIC PROTECTION ERA

DERA «NIZH-L» is designed for protection of armored vehicles of light weight category from unitary cumulative anti-tank threats



#### Protection type

Reduction of the armor piercing capability of the unitary RPG different types, anti-tank guided missiles with unitary and tandem warheads, cannonball ammunition

Dynamic, multifunctional

Provided with probability min 0,8 (for zones protected by DERA blocks)

#### Armor penetration with grenades

Enhanced protection from the bullets

- caliber 12,7 mm
- caliber 7,62 mm

Eliminated

at the following distances:

250 m  
50 m

#### Weight of 1m<sup>2</sup> of protection

200 – 250 kg

**RCWS AVAILABLE**



**BLIK-2M**



**IVA**



**SHTURM-M**



**PARUS**



**SARMAT-300**



**KASTET**



**DUPLET**



**STILET**

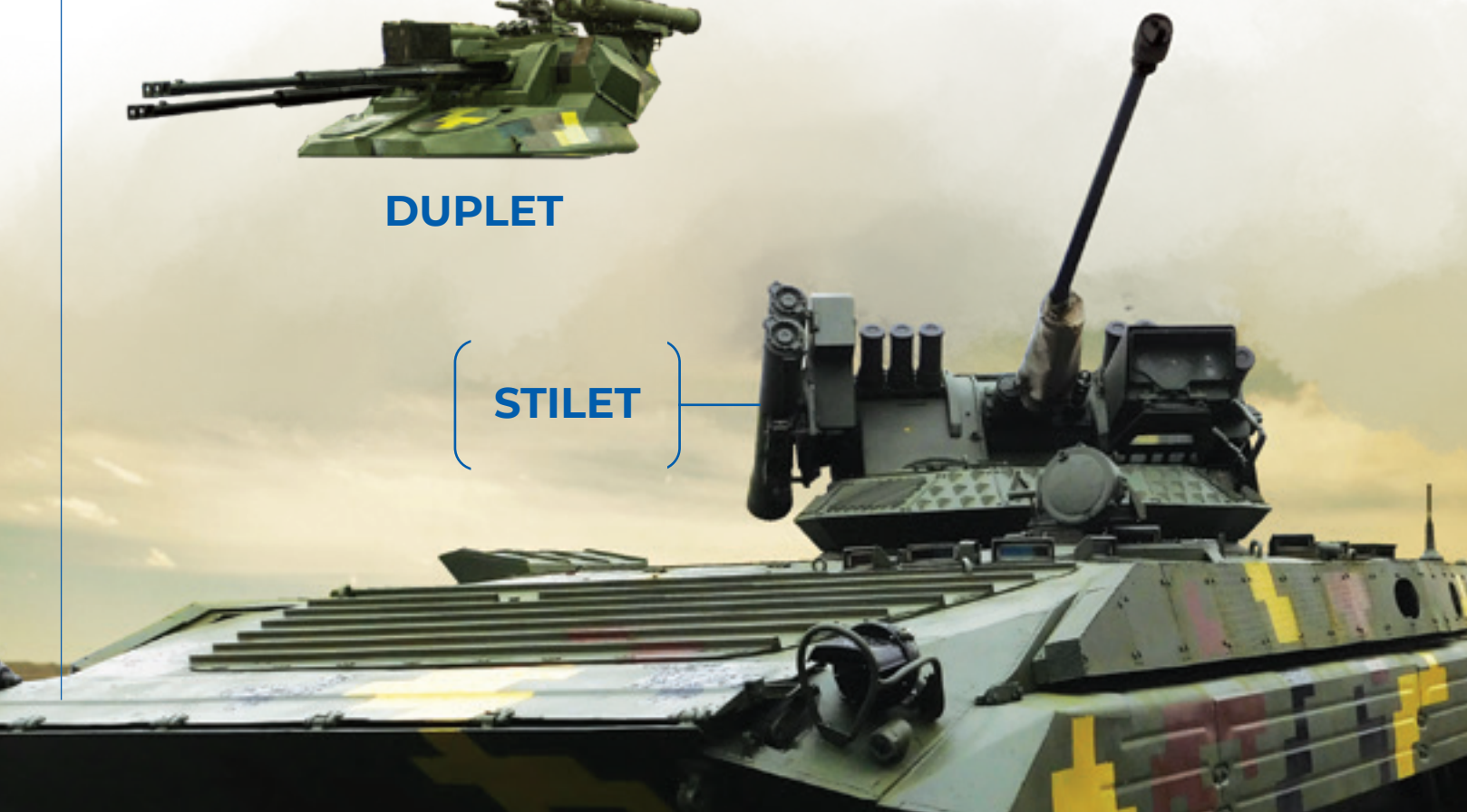

## BM-21U VERBA

### MULTIPLE LAUNCH ROCKET SYSTEM (122 mm)

BM-21U combat vehicle is designed for the destruction of:

- unprotected and sheltered enemy manpower and equipment
- armored personnel carriers, tanks, and other military equipment in areas of concentration
- artillery and mortar batteries, tactical missile batteries, helicopters on landing areas
- command posts, storage with fuel and ammunition
- other purposes



## BM-21UM BEREST

### MULTIPLE LAUNCH ROCKET SYSTEM (122 mm)

The combat machine consists of an artillery unit and a KrAZ-5401 NE chassis

#### THE COMBAT MACHINE HAS:

- electronic control unit for firing channels
- navigation system
- fire control system
- digital communication and reception and transmission of information

The BM-21UM Berest combat machine is designed for:

- destruction and suppression of the enemy's life and military equipment in the areas of their concentration
- destruction and suppression of artillery and mortar batteries
- destruction of fortifications, support points, and enemy resistance points



# NEPTUNE

## ANTI-SHIP MISSILE SYSTEM

NEPTUNE is a land-based anti-ship missile system. It is intended to defeat warships such as cruisers, destroyers, frigates, corvettes, tank landing ships and vehicles, which operate both independently and as part of the ship groups and amphibious groups, as well as coastal radio-contrast targets in visual and adverse meteorological conditions, under an active fire and electronic countermeasures by an enemy



**FIRING RANGE**  
up to 280 km



**QUANTITY IN SALVO**  
16 pcs



**TIME OF DEPLOYMENT**  
up to 15 min



**MAX AMMUNITION RESERVE**  
72 pcs



**MAXIMUM SPEED**  
70 km/h – on highway  
20 km/h – on off-road



**FIRING INTERVAL IN SALVO**  
from 3 to 5 s

# R-360 CRUISE MISSILE



**CONTAINER WEIGHT**  
up to 870 kg



**WARHEAD WEIGHT**  
150 kg



**DIAMETER**  
420 mm







## THE SYSTEM CONSISTS OF:



**MOBILE COMMAND POST**  
1 EA



**RK-360**  
4 EA in 1 launcher



**UNIFIED SELF-PROPELLED LAUNCHER**  
1 - 4 EA



**TRANSPORT-LOADING VEHICLE**  
1 - 4 EA



**TRANSPORT VEHICLE**  
1 - 4 EA



**SET OF GROUND EQUIPMENT**  
1 SET



## R-27 MODERNIZATION

### AIR-TO-AIR MISSILES

The R-27 is a medium-range, guided air-to-air missile. It is designed to intercept and destroy hostile piloted aircraft, drone targets, and cruise missiles in long-range and close-in maneuverable air fights. It features a modular three-part construction – the equipment and guidance section with a homing head, warhead, and solid-propellant rocket motor

The missile has three mounting points to the aircraft. It is compatible with the MiG and Su aircraft weapon systems



Type of missile	R-27ER1	R-27R1	R-27ET1	R-27T1	R-27EP1	R-27P1
Launch weight	350 kg	253 kg	343 kg	245 kg	346 kg	248 kg
Launch altitude	to 27 km	to 25 km	to 27 km	to 25 km	to 20 km	to 20 km
Maximum launch range, km head-on aspect / tail aspect	93 / 26	60 / 18	84 / 20	50 / 15	110 / –	78 / –
Guidance	Semi-active radar seeker with command updates		IR seeker		Passive guidance on radar and jammer	



## RS-80

### UNGUIDED AIRCRAFT ROCKETS

Unguided aircraft rocket RS-80 with shaped-charge fragmentation warhead represents an upgraded version of the unguided aircraft rocket S-8KOM. This rocket is designed to destroy hostile armored, lightly-armored, non-armored combat equipment and enemy fighters. It is used with Su and MiG fighter aircraft types, Mi and Ka helicopters types. It is designed to be launched from B8 launching pods and their modifications (analogs)



**CALIBER**  
80 mm



**ARMOR PENETRATION DEPTH  
(30° TO NORMAL)**  
Up to 430 mm



**ROCKET LAUNCHING MASS**  
12,8 kg



**LAUNCH RANGE**  
1000-5000 m



**MAXIMUM ROCKET VELOCITY**  
625 m/s



**EXPLOSIVE MASS**  
1,1 kg



**LENGTH**  
1595 mm



**WARHEAD MASS**  
4,6 kg

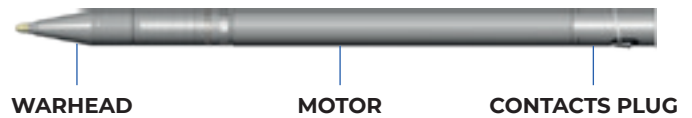



ایڈکس IDEX

**17 – 21 FEBRUARY 2025**  
**ADNEC CENTRE ABU DHABI**





SPETS  
TECHNO  
EXPORT

**PRODUCTS AND SERVICES  
PRESENTED BY STE  
AT IDEX 2025**

# MURAKHA

## GROUND-BASED ROBOTIC COMPLEX

The MURAKHA ground-based robotic complex is designed to support mechanized units and perform specific combat missions in difficult conditions under heavy enemy fire in mined areas of the frontline

Compatibility with 7,62 mm, 12,7 mm, and 14,5 mm caliber machine gun.



**OPERATING RANGE**  
30 km



**OPERATOR**  
1



**WEIGHT**  
490 kg



**MAX SPEED**  
9 km/h (paved road)  
7 km/h (off-road)



**EVACUATION**  
2+



**ANGLE OF ATTACK**  
55°



**LOAD CAPACITY**  
250-500 kg



**DIMENSIONS**  
1790 x 1230 x 690 mm



**RADIO COMMUNICATION**  
SIYI, ELRS  
· 10 km (open terrain)  
· 1 km (rugged terrain)

### MAIN TASKS:

1. Effective operation under intense enemy fire
2. Navigation and operation in mined areas of the frontline
3. Combat support for infantry during assaults, ambushes, defense, and reconnaissance
4. Evacuation of wounded from the battlefield
5. Supply of ammunition and provisions
6. Remote mine laying, demolition of bridges, and enemy vehicles
7. Towing of light vehicles



# DRONESQUAD FURY PRO

## HEAVY BOMBER

The DRONESQUAD FURY PRO heavy bomber is designed for delivery of munitions to enemy targets, destruction of heavy armored vehicles, fortified bunkers and concentrations of enemy personnel. The technology based on practical field experience, battle-tested and proven effective

Communication with the drone operators remained reliable without interruptions during testing. GPS remained stable, with a minimum of 8 out of 30 satellites



**OPERATING RANGE**  
 • 7 000 m (15 kg)  
 • 15 000 m (10 kg)

**FLIGHT TIME**  
 • 15 min (with payload)  
 • 55 min (empty)

**FREQUENCY RANGE**  
 • Control with an anti-jaming system  
 • Video 5.8/3.3 GHz

**PAYLOAD**  
 up to 15 kgt

**ACCURACY**  
 3-10 meters

**GPS SYSTEM**  
 Protected module from EW

**FLY MODES**  
 • Automatic with GPS  
 • Manual with GPS  
 • AltHold without GPS

**CAMERA**  
 • Day camera  
 • Thermal camera

**TYPES OF AMMUNITION**  
 • 1 x 120 mm cal. mine  
 • 3 x 82 mm cal. mines  
 • TM-62 anti-tank blast mine and others



# LORD D

## LONG-RANGE DRONE

The LORD UAV is a precision strike drone, designed for rapid mass production. It uses a cost-effective structure, piston engine, and fully automated GNC system, capable of long-range ultra-low-altitude flight over an adversary territory, including flying in a GNSS-denied environment

### MAIN FEATURES:

- Rapid mass production at extremely low costs with the easy-to-source off-the-shelf components
- Unmatched payload to price ratio
- A small radar cross-section and radio-silent operation make it ideal for low-profile missions
- The UAV is equipped with an anti-jamming system, ensuring mission success even in electronic warfare environment

**OPERATING RANGE**  
>800 km

**ENGINE**  
piston

**PAYLOAD**  
>40 kg

**SPEED**  
up to 140 km/h

**WINGSPAN**  
5000 mm

**MAX ALTITUDE**  
2000 m

**MAX TAKEOFF WEIGHT**  
100 kg

**LENGTH**  
3000 mm

**DEPLOYMENT TIME**  
15 min (3 operators 1 UAV)



### APPLICATIONS

- Long range kamikaze strike
- Training
- Target drone

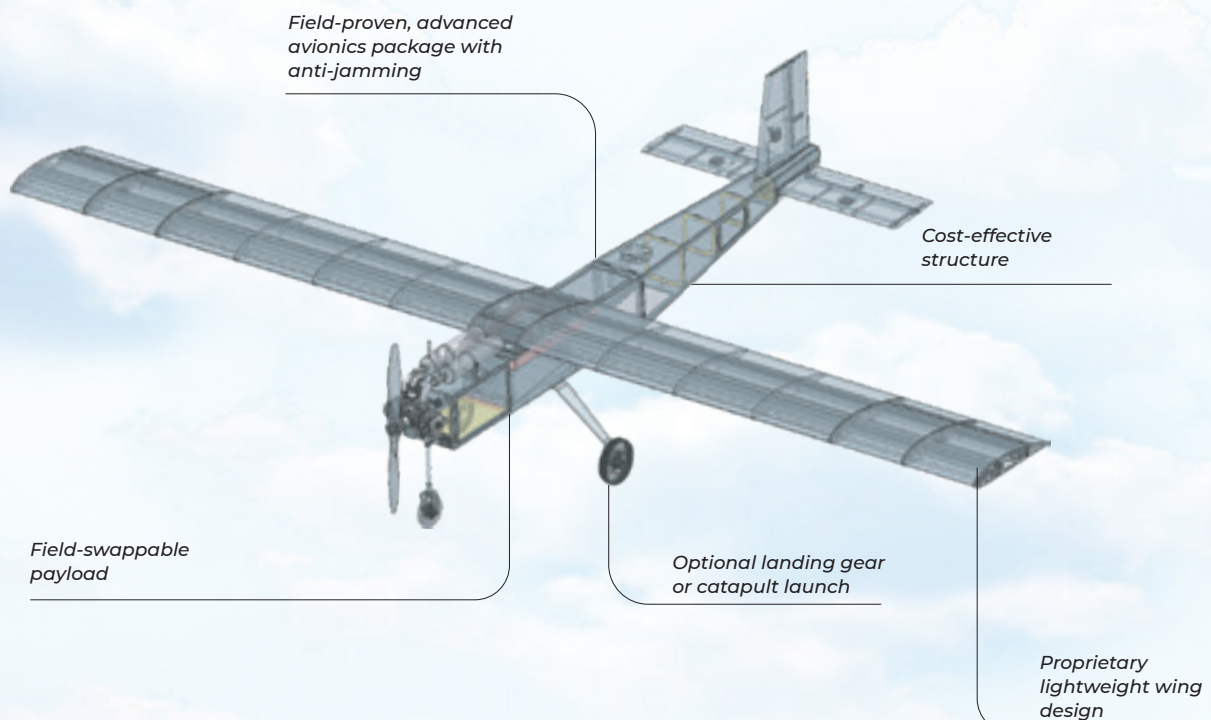



# HORNET

## INTERCEPTOR UAV

The Hornet interceptor UAV is an advanced autonomous ground-to-air drone-counter-drone system designed to counter swarms of kamikaze drones, reconnaissance UAVs or low-cost unguided missiles. It uses pioneering electric-driven ground-to-air interception technology

The system operates through an Anti-Drone Nodes (AND) network, each equipped with interceptor drones and detection radar

Hornet includes 4 strategic, high-value in-house developments: seeker, autonomous flight software, custom electronics, and modular airframe assembly

### MAIN FEATURES:

- Highly Efficient Canard Design
- Fully Autonomous after launch
- Quick Setup & Low Maintenance
- First-in-class hybrid seeker with acoustic sensors
- Cost-Effective: significantly more affordable than traditional air defense
- AI and machine learning is an essential part of the airborne and ground software

### APPLICATIONS

- Hostile drone interception
- Response to massive air attacks
- Air defense supplementation
- Shipborne air defense system
- Border protection
- Infrastructure protection
- Training

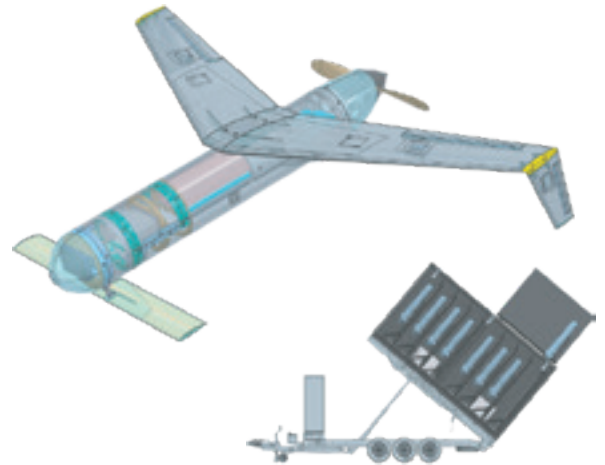

**INTERCEPTION RADIUS**  
up to 20 km

**TARGET GROUP**  
3 (large) <300 kg

**PAYLOAD**  
Direct – Fragmentation Warhead

**SPEED**  
300 km/h

**WINGSPAN**  
1500 mm

**TEMPERATURE RANGE**  
from -40°C to +40°C

**MAX TAKEOFF WEIGHT**  
10 kg

**LENGTH**  
1100 mm

Advanced hybrid homing system, allowing designation and tracking of the target

Wing-integrated Redundant GNSS

High-efficient twisted wing design with integrated winglets

An electric motor. The aircraft is fully electric, offering significant flexibility in terms of operations and reliability

The heart of the system is a proprietary autopilot

A booster enables the Hornet to achieve takeoff from a high-density rack

The canard configuration gives important aerodynamic advantages stability and manoeuvrability

Payload bay is equipped with FRAG warhead

The modular fuselage consists of 4 main sections: nose dome, payload bay, central fuselage and tail cone

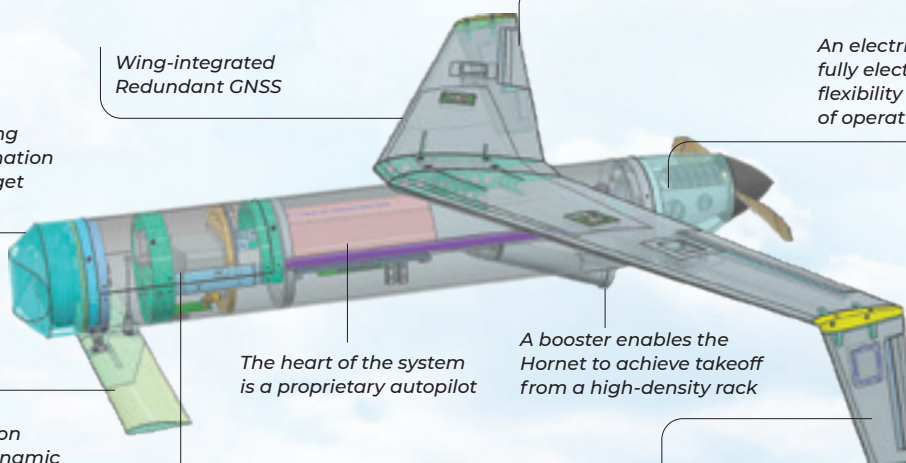

# RUTA

## REUSABLE TURBOJET AIRCRAFT

The RUTA turbojet aircraft is a low-cost drone-missile for frontline and rear area strikes. The structure is based on a cylindrical fuselage, detachable wings, and three movable tail control surfaces. The vehicle is launched by two rockets and is powered by a turbojet engine

The modular approach allows customer to change the payload to fuel ratio to solve a variety of tactical problems

It is a complete rethink of the concept of a universal cruise missile to achieve high competitiveness and proportionality in relation to challenges

### KEY FEATURES

- Ratio of price, payload capacity and speed, which makes it ideal for complex tactical missions
- Booster assisted take-off provides quick deployment time and the ability to launch literally from anywhere

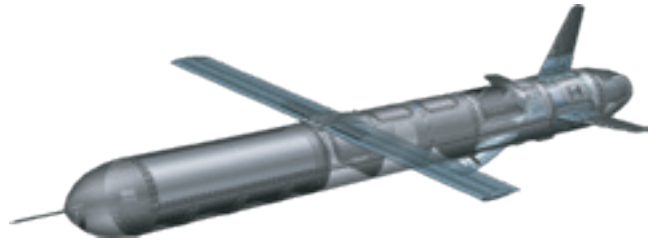

### APPLICATIONS

- Strike missions
- Target drone
- Engage various types of targets: lightly armoured vehicles, concrete structures and troops



#### MAX RANGE

up to 300 km (no wind)



#### EMPTY WEIGHT

85 kg



#### PAYLOAD

150 kg



#### CRUISE SPEED

979 km/h (M0.7)



#### WINGSPAN

2250 mm



#### ALTITUDE

3000 m (max)  
200 m (cruise)



#### MAX TAKEOFF WEIGHT

310 kg



#### LENGTH

3930 mm



#### TAKE-OFF

RATO (Rocket assisted take-off) system

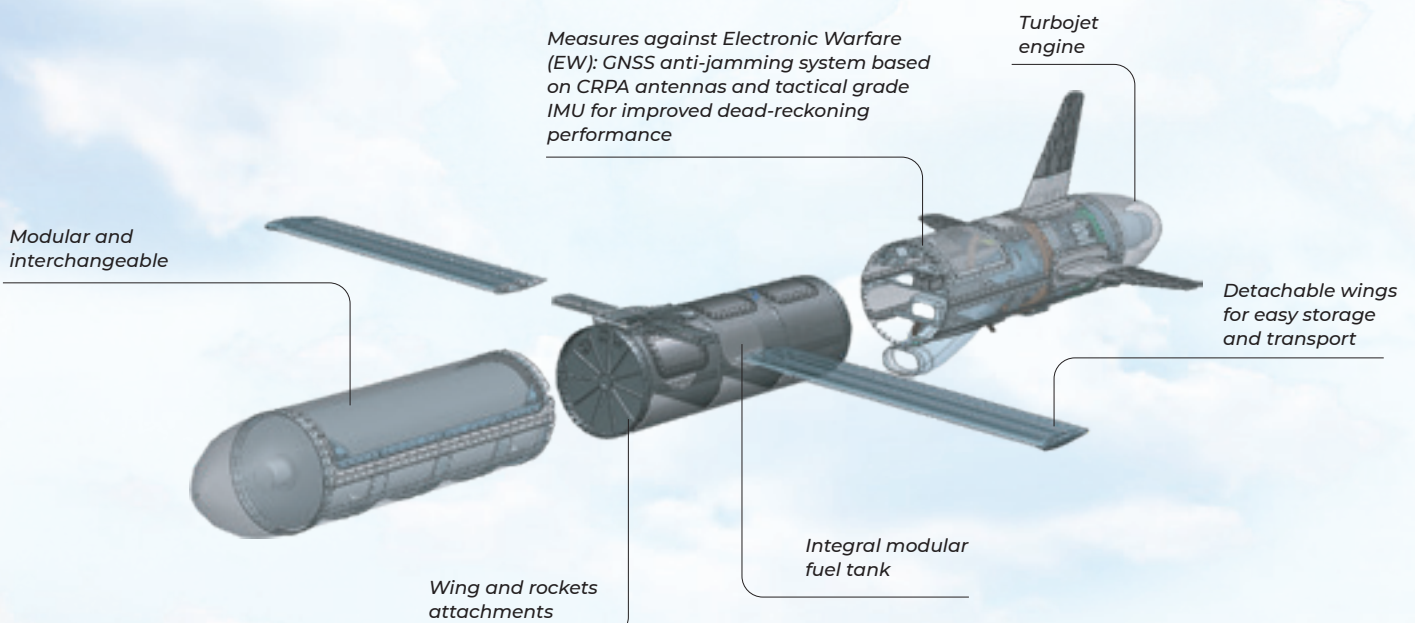

# BLITZ

## MULTIPURPOSE STRIKE / RECONNAISSANCE UAV COMPLEX

The number of options let The Blitz fulfill purposes of striking aircraft on both high and low altitudes or be used for tactical tasks such as target tracking and scouting

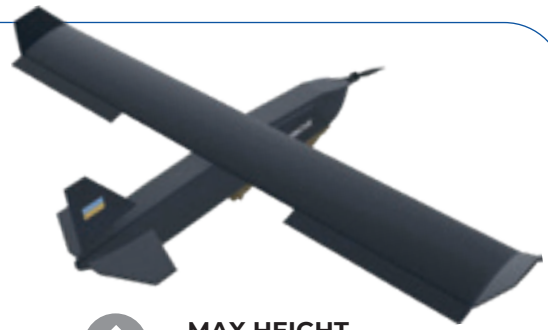

**WINGSPAN**  
1500 mm



**HEIGHT**  
600 m



**MAX HEIGHT**  
4000 m



**LENGTH**  
1100 m



**OPERATIONAL RANGE**  
up to 30 km



**FLIGHT TIME**  
20 – 60 min



**WEIGHT**  
5 kg



**SPEED**  
90 – 130 km/h



**ENGINE**  
electric

### KEY APPLICATIONS



STRIKE AIRCRAFT



TACTICAL RECONNAISSANCE  
AIRCRAFT



STRIKE AIRCRAFT  
FOR HIGH-ALTITUDE TARGETS  
(SLOW UAV SCOUTS)



OBU (ONE BUTTON USE)  
AIRCRAFT WITH AUTOPILOT AND  
AUTOMATIC TARGET TRACKING  
(FOR UNTRAINED PERSONNEL)



# CHAKLUN

## THE UAV COMPLEX FOR AERIAL RECONNAISSANCE



### MODIFICATIONS

- Reconnaissance
- Drop system
- Day
- Night

**The Chaklun  
has been officially approved for  
reconnaissance operation by the  
Ministry of Defence of Ukraine**

NATO NOMENCLATURE

1550-61-015-7322



Investigated by  
**AFU**  
from  
**2022**

# CHAKLUN

## THE UAV COMPLEX FOR AERIAL RECONNAISSANCE

The Chaklun UAV complex is a multifunctional mobile system designed for conducting aerial visual reconnaissance. Thanks to the unmanned aerial vehicles (UAVs) included in the complex, it can carry out reconnaissance, patrol, correction, and search operations. Due to their small size and the radio-transparent material of the body, the aircraft are almost invisible on radars, allowing them to penetrate deep into enemy territory undetected

Communication with the UAV operates through frequency-hopping spread spectrum which helps maintain control in areas affected by enemy electronic warfare (EW). The maximum communication range is 75 km



**LENGTH**  
960 mm



**WINGSPAN**  
1390 mm



**ENGINE TYPE**  
electric motor powered by battery



**TAKEOFF WEIGHT**  
2,8 ± 0,5 kg



**MAX FLIGHT ALTITUDE**  
3000 m



**OPERATING FLIGHT ALTITUDE**  
300 m



**OPERATING TEMPERATURE RANGE**  
from -15 to +30°C



**MAX WIND SPEED TOLERANCE**  
up to 12 m/s



**CRUISING SPEED**  
80 km/h



**MAX FLIGHT SPEED**  
125 km/h



**MIN FLIGHT SPEED**  
55 km/h



**MAX FLIGHT DURATION**  
up to 2 hours



**MAX RANGE IN MANUAL MODE**  
at least 50 km



**MAX RANGE IN AUTONOMOUS MODE**  
at least 70 km



**LAUNCH METHOD**  
hand-launched by operator or using a launch device



**LANDING METHOD**  
free descent (aircraft-style landing)

### THE CHAKLUN COMPOSITION OF THE UAV COMPLEX

1. The Chaklun UAV Aircraft - 2 units
2. Ground Control Station
3. Launching Device

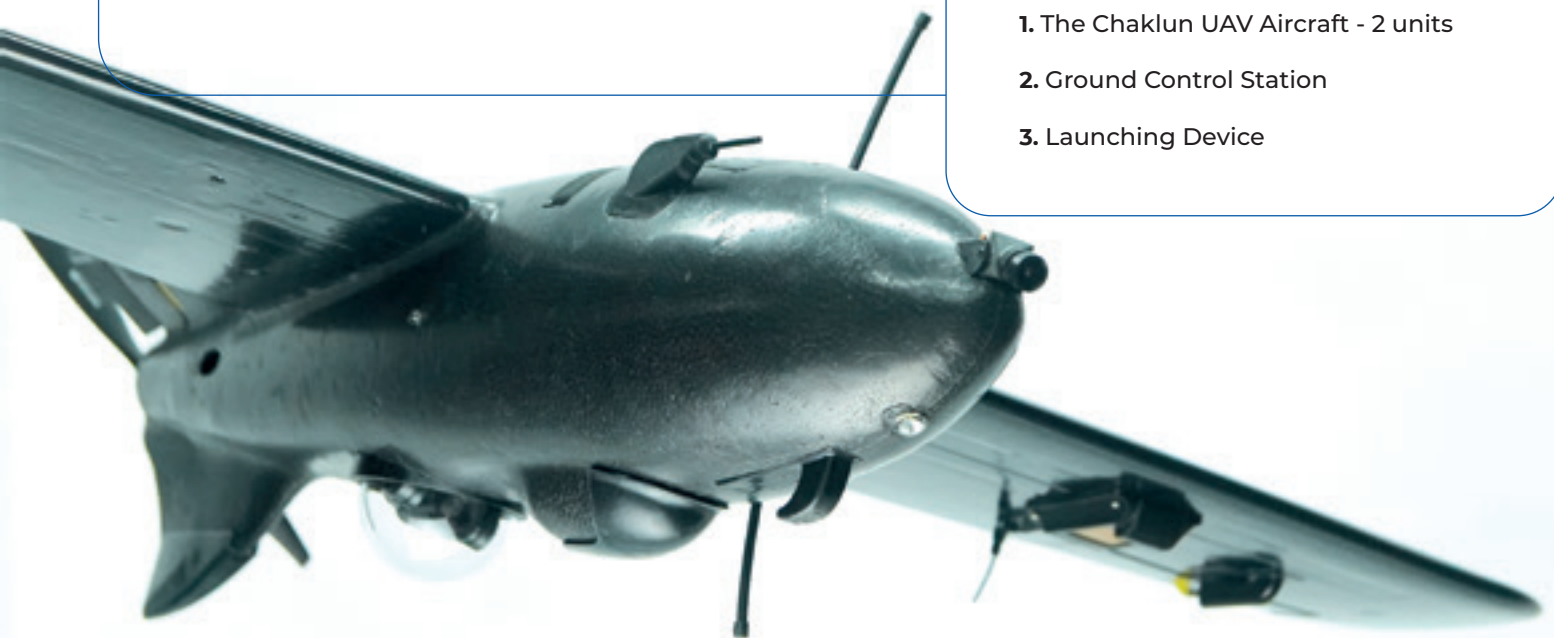

# CHAKLUN-B

## UAV SYSTEM



### THE CHAKLUN-B COMPOSITION OF UAV SYSTEM

1. The Chaklun B Aircraft - 1 unit
2. Ground Control Station
3. Launching Device

**Built using a conventional aircraft design, this UAV can stay airborne for up to 6 hours while carrying a payload up to 15 kg**



# CHAKLUN-B

## UAV SYSTEM

The Chaklun-B UAV is an aircraft designed for carrying payloads. An integrated inertial system, along with software developed specifically for this UAV, ensures stable flight in automatic mode based on predetermined coordinates

These features can be adapted for executing special combat missions, as well as for mapping, or delivering cargo to remote areas during peacetime



**FUSELAGE LENGTH**  
2200 mm



**WINGSPAN**  
3100 mm



**ENGINE TYPE**  
Internal combustion engine (ICE)



**TAKEOFF WEIGHT**  
43-45 kg



**MAX FLIGHT ALTITUDE**  
up to 3000 m



**OPERATING TEMPERATURE**  
from -10 to +30°C



**TARGET EQUIPMENT**  
10-15 kg (depending on fuel tank capacity and flight duration)



**CRUISING AIRSPEED**  
130 km/h



**MAX FLIGHT SPEED**  
155 km/h



**MAX FLIGHT DURATION**  
up to 6 hours



**GUARANTEED MINIMUM FLIGHT RANGE**  
600 km



**LAUNCH METHOD**  
manual takeoff  
(automatic mode during the main flight)



**LANDING METHOD**  
free descent  
(airplane-like landing)



**TAKEOFF RUNWAY**  
from grass airstrips or artificial runways,  
with a takeoff roll of at least 100 meters.  
Catapult launch is used for one-way strike missions



# CHAKLUN-B 2.0

## UAV SYSTEM

### THE CHAKLUN-B 2.0 COMPOSITION OF THE UAV SYSTEM

1. UAV aircraft – 1 unit
2. Ground control
3. Control panel



**Built using  
a conventional aircraft design,  
it can remain airborne  
for approximately 8 hours  
while carrying a payload  
up to 20-25 kg**





## CHAKLUN-B 2.0

### UAV SYSTEM

The Chaklun-B 2.0 UAV is an aircraft designed for transporting payloads. An integrated inertial system, along with software developed specifically for this UAV, ensures stable flight in automatic mode based on predetermined coordinates

These capabilities can be adapted for executing special combat missions, as well as for mapping and delivering cargo to remote areas during peacetime



**FUSELAGE LENGTH**  
2500 mm



**WINGSPAN**  
3500 mm



**ENGINE TYPE**  
internal combustion engine  
(ICE)



**TAKEOFF WEIGHT**  
up to 65 kg



**MAX FLIGHT ALTITUDE**  
up to 3000 m



**OPERATING TEMPERATURE**  
-10 to +30°C



**CRUISING AIRSPEED**  
130 km/h



**MAX FLIGHT SPEED**  
155 km/h



**PAYLOAD**  
20 – 25 kg



**MAX FLIGHT DURATION**  
up to 8 hours



**GUARANTEED MIN FLIGHT RANGE**  
900 km



**LAUNCH METHOD**  
manual takeoff  
(automatic mode during the mainflight)



**LANDING METHOD**  
free descent (airplane-like landing)



**TAKEOFF**  
runway from grass airstrips or artificial runways,  
with a takeoff roll of at least 100 m.  
Catapult launch is used for one-way strike missions



**TARGET EQUIPMENT**  
20 – 25 kg  
(depending on fuel tank capacity and flight duration)



# CHAKLUN-K

## UAV SYSTEM

Over  
**2000**  
successful  
neutralization  
of enemy  
targets



NATO NOMENCLATURE

1550-61-015-8962

**Advanced control and telemetry transmission system ensures a range of up to 30 km, while a secure communication channel allows it to maintain control even in areas affected by enemy electronic warfare (EW) systems**

**CHAKLUN-K (A)** – Autonomous Version.  
This is a fixed-wing drone also for ground operations, designed to strike lightly armored vehicles, communication systems, EW stations, fuel tankers, and moving targets

**CHAKLUN-K (M)** – Modernized Version.  
This is a fixed-wing fighter drone for air-to-air operations, specifically designed to neutralize aerial targets such as reconnaissance drones (e.g., Zala, Supercam, Orlan, Merlin). With an enhanced engine and specialized design, the UAV can reach speeds of up to 175 km/h, enabling it to quickly intercept and destroy its target



# CHAKLUN-K

## THE UAV COMPLEX PAYLOAD CARRIER

Available in three modifications for ground and air operations  
The UAV Complex "Chaklun-K" is a mobile strike system designed for transporting payloads (up to 1 kg) to pre-identified ground or moving air targets. The system is highly versatile, allowing the UAV to perform tasks both on the ground and in the air, with different technical specifications



### CHAKLUN-K (A) Autonomous Version

### CHAKLUN-K (M) Modernized Version

 **LENGTH OF THE AIRFRAME**  
960 mm

 **WINGSPAN**  
1390 mm

 **ENGINE TYPE**  
Electric motor

 **MAX TAKEOFF WEIGHT**  
4,3 ± 0,1 kg

 **MAX FLIGHT ALTITUDE**  
4000 m

 **OPERATIONAL FLIGHT ALTITUDE**  
(A) 300 m  
(M) 4000 m

 **OPERATING TEMPERATURE RANGE**  
-15° to +30°C

 **MAX WIND SPEED**  
up to 12 m/s

 **CRUISE SPEED**  
80 km/h

 **MAX FLIGHT SPEED**  
(A) 120 km/h  
(M) 175 km/h

 **MIN FLIGHT SPEED**  
60 km/h

 **MAX FLIGHT DURATION**  
1 h ± 10 min

 **MAX RANGE IN CONTROLLED MODE**  
50 km

 **LAUNCH METHOD**  
from a launch device

 **LANDING METHOD**  
free descent  
(aircraft-type landing)

 **PAYLOAD**  
2 kg

 **UAV CREW**  
3 persons

 **RADAR CREW (RLS)**  
3 persons

### THE CHAKLUN-K SYSTEM COMPOSITION:

1. The Chaklun K Aircraft - 6 unit
2. Ground Control Station
3. Launching Device

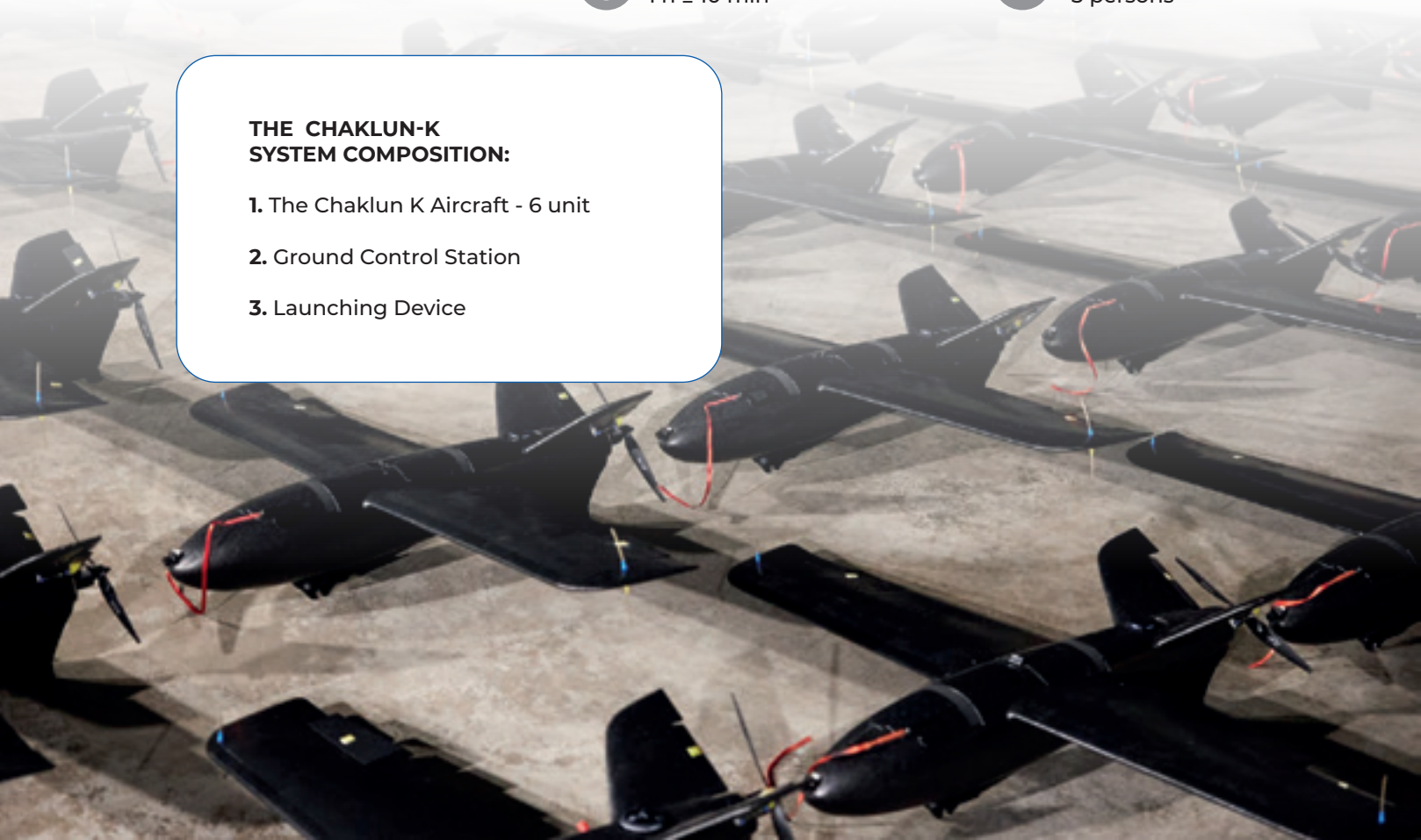

# INTERCEPTOR

## THE UAV FIGHTER COMPLEX

### MODIFICATIONS

- Day
- Night
- Shot

The aircraft's design allows it to stay airborne for more than 2 hours (in patrol mode) and to pursue targets at maximum speeds of 250 km/h

More than  
**1,000**  
successful intercepts  
of enemy targets

### NATO NOMENCLATURE

NCAGE Code – A4K9J

1550-61-018-1910

1550-61-018-0431

# INTERCEPTOR

## THE UAV FIGHTER COMPLEX

The Interceptor UAV system is designed exclusively for neutralizing airborne targets (enemy reconnaissance and strike UAVs). It is equipped with two cameras, providing a wide field of view, and can also be fitted with a thermal imaging camera for night operations



**FUSELAGE LENGTH**  
1000 ± 6 mm



**WINGSPAN**  
1706 ± 6 mm



**MAX TAKEOFF WEIGHT**  
6 kg



**PAYLOAD**  
up to 800 g



**MAX FLIGHT ALTITUDE**  
6500 m



**OPERATIONAL FLIGHT ALTITUDE**  
from 1000 to 4000 m



**OPERATING TEMPERATURE**  
-10 to +30 °C



**MAX WIND SPEED LIMIT**  
up to 12 m/s



**CRUISING AIRSPEED**  
90 km/h



**MAX FLIGHT SPEED**  
250 km/h



**MIN FLIGHT SPEED**  
70 km/h



**MAX RANGE**  
currently up to 30 km in controlled flight  
limited by electronic warfare (EW)



**UAV FLIGHT DURATION**  
from 20 to 60 minutes



**LAUNCH METHOD**  
launcher



**BATTERY**  
25 V lithium-ion battery, capacity from 20,000 mAh



**UAV CREW**  
3 people



**RADAR CREW**  
3 people



### THE INTERCEPTOR SYSTEM COMPOSITION:

1. The Interceptor UAV Aircraft - 10 units
2. Ground Control Station
3. Launching Device

## ANTI-UAV

### INTERCEPTOR UAV

The aircraft is equipped with various target acquisition systems. This allows the aircraft to hit the target regardless of weather conditions

The high speed helps to destroy almost all known UAVs. In turn, the 8 kg payload makes it possible to use this aircraft for various tasks by increasing the battery capacity and flight range. With the addition of certain equipment, the aircraft can be used as a decoy target

The low cost of the UAV, combined with its other advantages, makes it one of the best in its class. Time to deploy and prepare for use - 1 minute

Production capacity of up to 3 thousand units per month



**WINGSPAN**



**CURB WEIGHT**

up to 12 kg



**MAX ALTITUDE**

4000 m



**LENGTH**

1500 mm



**OPERATIONAL RANGE**

8 km



**FLIGHT TIME**

20 min



**HEIGHT**

400 mm



**MAX SPEED**

250 km/h



**ENGINE**

electric x 2

A high-speed interceptor UAV designed to combat reconnaissance and attack aircraft. It is launched from the ground and can be equipped with a target acquisition and homing module



# PHOTON









## FPV DRONE

FPV fighter drones with frames up to 15 inches in diameter, payloads up to 7 kg and a range of up to 20 km

They can be equipped with 3 types of cameras:

- ◆ daytime camera
- ◆ night vision camera
- ◆ thermal camera

The drone can be equipped with a fiber optic control system or with an optional target capture board

-  **WEIGHT**  
up to 2.5 kg (with battery)
-  **OPERATIONAL RANGE**  
up to 20 km
-  **FLIGHT DURATION**  
up to 15 min with payload  
up to 25 min (without payload)
-  **MAX FLIGHT ALTITUDE**  
up to 500 m
-  **MAX FLIGHT SPEED**  
up to 130 km/h
-  **PERMISSIBLE WIND LOAD**  
up to 15 m/s
-  **TEMPERATURE RANGE**  
from -20 to +50°C
-  **PAYLOAD**  
up to 7 kg
-  **VIDEO TRANSMITTER POWER**  
1.6 W or 2.5 W



### MODULE OF AUTOMATIC TARGETING (HOMING) OF AN AIRBORNE WEAPON

#### DESIGNED FOR:

autonomous control of an aerial weapon (FPV drone, autonomous or barrage munition) after the operator points it at the target and transfers the functions of maintaining the direction to the target from the operator to the MODULE

Target acquisition and heading maintenance on moving and stationary objects from a distance of up to 1000 meters

Automatic (without operator intervention) target tracking from the moment the module is activated until the target is hit or the operator cancels the mission

Autopilot mode: the drone is able to pass through the EW impact zones in automatic mode

Possibility to use day and night (thermal imaging) vision with cameras

 **DIMENSIONS**  
100 x 65 x 20 mm

 **MODULE WEIGHT**  
up to 200 g

Mounting the module with slings in an arbitrary place.

Protective housing IP65



# BEAVER 1-20

## MINI FPV-DRONE

The Beaver 1-20 mini FPV-drone is a module structured reliable and stable system designed in order to reach goals in tactic purposes

Manufacturability allows customer to take advantage of a significant number of options and activate drone remotely



**OPERATING RANGE**  
up to 24 km



**PAYLOAD**  
up to 2 kg



**OPERATING TIME**  
up to 40 min

### "ALL-IN-ONE" BOARD



### CHANGEABLE COMPONENTS

#### ANTENNA UNIT



**RC-DIVERSITY**  
Band 1: 750-1000 MHz  
Band 2: 2.4 GHz  
VTX: 5.8 GHz



**RC-DIVERSITY ENCRYPTED 256**  
Band 1: 400 MHz  
Band 2: 900 MHz  
VTX: 5.8 GHz

#### PAYLOAD

1 - 2 kg



#### MUNITION INITIATION SYSTEM



#### OPTICS



analog



digital



nightvision



SPECS	ENDURANCE	RANGE
1 kg	24 min	32 km
1.5 kg	18 min	24 km
2 kg	14 min	18 km

\*The measurements were taken at a temperature of 20°C, with wind speed of 0 m/s, at a cruising speed of 80 km/h



# J.E.T.

## FPV DRONE

The J.E.T. drone is designed to destroy the enemy personnel, light and medium-armored vehicles, communication infrastructure, light defensive facilities within the tactical depth

It demonstrates high quality and reliability, validated by extensive combat experience, as well as systematic and effective execution of combat missions

Control of the drone is ensured by the operator using the ground control station JET GS v1.3.



### JET-2

#### 8-INCH FPV DRONE



**OPERATING RANGE**  
13 km



**SPEED**  
70-80 km/h (cruise)  
140 km/h (in attack mode)



**FLIGHT TIME**  
13 min (cruise speed)  
9 min (max speed)



**PAYLOAD**  
2 kg



**BATTERY**  
up to 9 000 mAh



**FLIGHT ALTITUDE**  
up to 1 500 m

### JET-10

#### 10-INCH FPV DRONE



**OPERATING RANGE**  
13 km



**SPEED**  
70-80 km/h (cruise)  
120 km/h (in attack mode)



**FLIGHT TIME**  
15 min (cruise speed)  
13 min (max speed)



**PAYLOAD**  
3 kg



**BATTERY**  
up to 12 000 mAh



**FLIGHT ALTITUDE**  
up to 1 500 m

### OPTIONAL MUNITION TYPES



**HEX-RF3-1300i**  
Axial-action  
ammunition

**WEIGHT**  
1300 g

**EFFECTIVE FIRING RANGE**  
not less than 10 m



**PG7-CF**  
Munition of  
cumulative effect

**WEIGHT**  
1500 g

**EFFECTIVE FIRING RANGE**  
not less than 5 m



**HEX-1000F**  
Fragmentation  
munition

**WEIGHT**  
2700 g

**EFFECTIVE FIRING RANGE**  
not less than 8 m

## LSCFG-05-792-1,2kg

### DUAL-PURPOSE WARHEAD

Combines cumulative and high-explosive fragmentation principles of action. It is used against vehicles and lightly armored vehicles (IFVs, APCs), including those with troops on the roof, light fortifications, and open storage areas for ammunition and fuel.

 **MAX TAKEOFF WEIGHT**  
1,2 kg

 **ARMOR PENETRATION AT A 90°**  
100 mm

 **ARMOR PENETRATION AT A 45°**  
50 mm

 **DAMAGE RADIUS**  
8 m

 **WEIGHT OF FRAGMENT**  
0,5 g

 **NUMBER OF FRAGMENTS**  
792 pcs



## LSCFGH-09-792-1,9kg

### DUAL-PURPOSE WARHEAD

Features increased armor penetration and penetrating action of fragments, combining cumulative and high-explosive fragmentation principles of action. It is used against vehicles and lightly armored vehicles (IFVs, APCs), including those with troops on the roof, buildings, light fortifications, and open storage areas for ammunition and fuel.

 **MAX TAKEOFF WEIGHT**  
1,9 kg

 **ARMOR PENETRATION AT A 90°**  
150 mm

 **ARMOR PENETRATION AT A 45°**  
75 mm

 **DAMAGE RADIUS**  
8 m

 **WEIGHT OF FRAGMENT**  
0,9 g

 **NUMBER OF FRAGMENTS**  
792 pcs



## EFP-S-1.0kg

### ANTI-ARMOR WARHEAD

The **EXPLOSIVELY FORMED PENETRATOR** warhead has powerful beyond-armor effect and a long-range striking distance (from 1.5 to 20 meters). It is used against lightly armored vehicles (SPGs, IFVs, APCs) that are protected by anti-cumulative and anti-drone defenses.

 **MAX TAKEOFF WEIGHT**  
1,0 kg

 **ARMOR PENETRATION AT A 90°**  
30 mm

 **MIN RANGE FOR ENGAGEMENT**  
1,5 m

 **MAX EFFECTIVE RANGE**  
20 m

 **WEIGHT OF THE PENETRATOR**  
160 g

 **SPEED OF THE PENETRATOR**  
1800 m/s



## FRAG-05-975 0.9 kg

### ANTI-PERSONNEL WARHEAD

**ANTI-PERSONNEL** with a high-density fragmentation field and a lightweight design. Used against infantry in open terrain and open storage areas for ammunition.



**MAX TAKEOFF WEIGHT**  
0,9 kg



**WEIGHT OF FRAGMENT**  
0,5 g



**DAMAGE RADIUS**  
8 m



**NUMBER OF FRAGMENTS**  
975 pcs



## FRAG-05-1480 1.4 kg

### ANTI-PERSONNEL WARHEAD

**ENHANCED ANTI-PERSONNEL** with increased explosive effect, penetrating fragments, and larger damage sector. Used against infantry, light fortifications, observation equipment, antennas, and ammo storage.



**MAX TAKEOFF WEIGHT**  
1,4 kg



**WEIGHT OF FRAGMENT**  
0,5 g



**DAMAGE RADIUS**  
8 m



**NUMBER OF FRAGMENTS**  
1480 pcs



## FRAG-09-576 1.3 kg

### GENERAL-PURPOSE WARHEAD

**GENERAL PURPOSE**, it has an increased explosive effect and penetrating action of fragments. It is used against vehicles, light fortifications, and ammo storage.



**MAX TAKEOFF WEIGHT**  
1,3 kg



**WEIGHT OF FRAGMENT**  
0,9 g



**DAMAGE RADIUS**  
4 m



**NUMBER OF FRAGMENTS**  
576 pcs



## FRAG-09-2040 3.1 kg

### GENERAL-PURPOSE WARHEAD

**GENERAL PURPOSE**, it has a powerful explosive effect, an increased damage radius, and a penetrating action of fragments. It is used against vehicles, infantry, buildings, light fortifications, and ammo storage.



**MAX TAKEOFF WEIGHT**  
3,1 kg



**WEIGHT OF FRAGMENT**  
0,9 g



**DAMAGE RADIUS**  
8 m



**NUMBER OF FRAGMENTS**  
2040 pcs



## NEBOKRAY AO 1.0, AOS 1.2.

### ANTENNA UNIT

The antenna unit can be autonomous, making the product universal:

- ◆ For vehicles and armored vehicles with antenna mounted on the roof
- ◆ Protection of bunkers, trenches with external antenna extension
- ◆ Attack with carrying case for mobility
- ◆ Ergonomic backpack for easy transportation

In case of interference on all frequencies works up to 1,5 hours

Quick on/off interference setting in all five frequency bands

220 V and 12 – 24 V mains charging

Total output power of each module 50 – 100 W

Featuring metal housing, waterproof, heat resistant, corrosion resistant due to powder coating.

Product have a cooler with automatic ventilation system and replaceable lithium battery with operating time more than 3 hours



- **PROVIDES SUPPRESSION OF**
  - FPV control channels;
  - Telemetry channels from UAVs, namely DJI, Autel
- **FREQUENCY SUPPRESSION SPECTRUM**  
433 – 1560, separately 2.4 – 5.8 GHz
- **SUPPRESSION RANGE**  
300 – 700 metres\* (1.0)  
250 – 500 metres\* (1.2)
- **PATCH ANTENNAS WITH A GAIN COEFFICIENT OF AT LEAST 12 DBI, OMNIDIRECTIONAL**  
circular, hemispherical protection

\* Depending on the distance from the operator to the equipment



#### DIMENSIONS

*housing:*

**AO 1.0:** 700 x 480 x 180 mm

**AOS 1.2:** 500 x 480 x 180 mm



*antenna block:*

600 x 400 x 400 mm



*battery:*

480 x 180 x 140 mm



#### WEIGHT

**AO 1.0:** up to 24 kg

**AOS 1.2:** up to 19 kg



300-700m



## ANTI-SKID

### MODULAR ELECTRONIC WARFARE SYSTEM

The electronic warfare system provides protection of manpower and equipment from enemy UAVs. The automatic frequency scanning module allows detecting enemy drones and jamming their frequency. The device uses dome antennas, which provides comprehensive protection of the object



Weight from 12 kg with modules for 2 frequencies and up to 60 kg with modules for 10 frequencies without battery Has IP 68 protection and meets military standards MIL-STD-810G, MIL-STD-461G Ground Navy Effectively works against FPV drones with a frequency range of 240 to 1500 MHz at a distance of 70 m

With Mavic and Autel drones at 2.4 and 5.8 GHz at an altitude of 200 m and a distance of 160 m the battery provides up to 3 hours of operation at full load



**BATTERY**  
up to 3 hours



**FREQUENCY RANGE**  
240 – 1500 MHz



**WEIGHT**  
12 – 60 kg

### THE VERSION OF THE ELECTRONIC WARFARE SYSTEM

- ✦ **With up to 10 frequencies** is designed in a modular style
- ✦ **This allows you to quickly replace jammers** with more relevant frequencies **in a particular area of the front**
- ✦ Thanks to a **powerful battery**, it can operate continuously with all frequencies **enabled for up to 5 hours**
- ✦ It can be used both **to protect static objects** and to **be installed on moving vehicles**

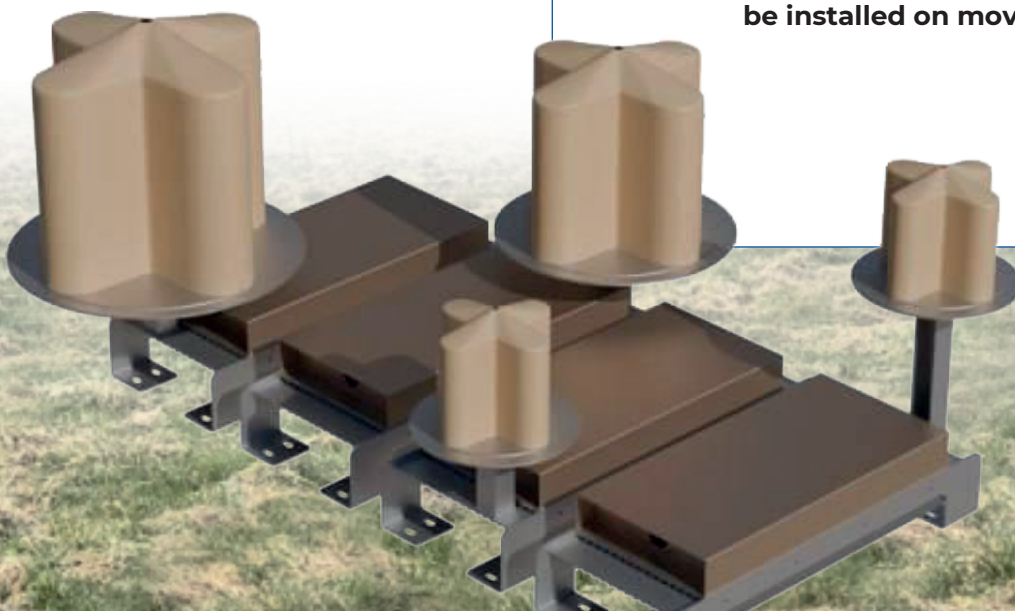

## OCHI-1











### ELECTRO-OPTICAL THERMAL DETECTION COMPLEX

First in the world thermal imaging equipment for “ground-to-air” operations, specifically designed for mobile fire groups (MFGs) that use ZU-23, Browning M2, DShK, NSVT, PKM, KPVT, and other types of weapons

The use of special lenses, combined with precise calibration of thermal imaging sensors, has facilitated significant advancements in the early detection of various types of aerial targets over long distances, enhancing their engagement capabilities both day and night



#### COMPLEX INCLUDES:

-  Thermal Scope LTV Sky 640 50 mm + IP-67 Housing
-  Complex Control Computer + IP-67 Housing
-  Picatinny Rail
-  Monitor with Weather Protection
-  Monitor Mount with Vibration Dampening
-  Operator`s Zoom Control Unit
-  Power Bank/Charging Station 200 W, 172 Wh
-  Connection Kit (cables, adapters)
-  Scope Modification for UART Control
-  Specialized Micro PC Software
-  Transportation Case

#### ADDITIONALLY

Complex can be equipped with platforms, specialized communication systems, laser pointers, searchlights, and vehicles. All the above-mentioned offerings can be installed on a turnkey basis. Warranty. Ukrainian manufacturer.



## OCHI-T1

### UNIVERSAL ELECTRO-OPTICAL COMPLEX

The OCHI-T1 complex can be installed on combat vehicles of any type, equipped with firearms, cannons, and missile weapons. It is designed for visual detection, tracking, and subsequent engagement of both ground and aerial targets, day and night



#### COMPLEX INCLUDES:



##### IP67 DUAL CAMERA MODULE

- Thermal Imaging Scope: 640x480 sensor / 50mm, F 0.8 lens.
- Optionally: 1280x1024 px/12 μm, 60 Hz sensor, 50 mm lens.
- Day/Night Camera



IP-67 Protected Processing Unit



Operator`s Zoom Control Unit



Universal Control Panel Board: developed with 20 functional buttons functionality can be customized according to customer requirements).



Monitor with Weather Protection



Monitor Mount with Vibration Dampening



Scope Modification for UART Control



#### ADDITIONALLY

- ◆ IP67/IP68 scopes block housing. Optionally, it can be installed in a lightly armored housing
- ◆ The scopes` block can optionally be equipped with a laser target designator and a spotlight



## ATN TGP-7UA 320

### THERMAL SCOPE FOR RPG-7

The RPG-7 grenade launcher was specifically developed for use against tanks, self-propelled artillery units, and other types of enemy armored vehicles, as well as against personnel, both in open terrain and in shelters. With the introduction of the PG-7V grenade, infantry gained an even more powerful and effective tool for accurately engaging concentrations of enemy personnel



The highest effectiveness of RPG-7 fire is achieved when using thermal imaging scopes. The presence of RPG-7 units equipped with thermal imaging scopes in combat groups/subunits undoubtedly enhances their firepower effectiveness and provides almost unparalleled superiority over the enemy in this segment of armament

Equipping the RPG-7 with a thermal imaging scope significantly expands its capabilities and endows it with unique features

It enables the use of the grenade launcher in anti-sniper night combat, greatly increases effectiveness in countering enemy special forces, and facilitates reconnaissance and sabotage missions

The TGP-7 scope series is developed based on the time-tested thermal imaging scopes from ATN company, namely the Mars 4 series and the latest Mars LTV models. Thanks to ATN's thermal imaging technologies, the range of accurate shooting sometimes doubles, making it fully feasible for combat operations with RPG-7 at night

The TGP-7 reticle is governed by the rules for using a standard reticle scope for RPG-7 PGO- 7V3, with significant improvements. An experienced operator adapts to working with the new scope after a single shot. An experienced operator adapts to working with the new scope after a single shot

**MAGNIFICATION**  
3x – 9x

**WEIGHT**  
650 g

**SENSOR RESOLUTION**  
320 x 240 px/12 μm

**HUMAN DETECTION RANGE**  
715 m

**DIMENSIONS**  
292 x 56 x 55 mm

**VEHICLE DETECTION RANGE**  
1000 m





## THERMAL IMAGING SCOPE FOR FIM-92 STINGER MANPADS

Thermal scope enables the detection and engagement of warm, moving targets in the sky day and night. The detection range of targets in the sky by type. The detection range of targets in the sky depends on their type. These scopes for FIM-92 MANPADS can cover the shortage in the Armed Forces of Ukraine, thereby increasing the effectiveness of hitting air targets by air defense forces



**SENSOR RESOLUTION**  
640 X 480



**MAGNIFICATION**  
1,5x – 15x



**FIELD OF VIEW**  
24 X 19°



**HUMAN DETECTION RANGE**  
1050 m



**VEHICLE AND HUMAN RECOGNITION RANGE**  
530 m



**VEHICLE AND HUMAN IDENTIFICATION RANGE**  
330 m



**COLOR MODES**  
white hot / black hot / color



**RETICLE**  
according to the type of weapon



**DEVICE READY TIME**  
15 s



**VIDEO RECORDING**  
yes



**MICRO SD CARD**  
from 4 to 64 gb



**BATTERY LIFE (LITHIUM-ION)**  
up to 10 hours



**EXTERNAL POWER SOURCE SUPPORT**  
yes



**OPERATING TEMPERATURE RANGE**  
-25° to + 40°C



**DIMENSIONS**  
343 x 76 x 76 mm



**WEIGHT**  
920 g



# ATA GEAR

## KYDEX HOLSTERS

- ◆ The largest manufacturer of Kydex holsters in Europe
- ◆ Reliability and durability. High-quality certified materials only
- ◆ All products are designed with input from tactical experts and approved by users in real fire contact
- ◆ Customer focus: individual approach to orders and strong post sale support



### FANTOM

inside the waistband holster

- ◆ Maximum hidden carry
- ◆ Securely fits and takes up minimal space
- ◆ Perfect for use under light clothes

Best suitable for: Civilians, Bodyguards



### HIT FACTOR

outside the waistband holster

- ◆ Comfortable concealed carry
- ◆ Easy access to your gun
- ◆ Perfect combination with jackets

Best suitable for: Civilians, Bodyguards, Military



### CIVILIAN DEFENDER

inside the waistband holster

- ◆ Hidden carry of a handgun and additional magazine for it
- ◆ Front placement provides quick access to weapon
- ◆ Addaptive to users' body shape

Best suitable for: Civilians, Bodyguards



### ON DUTY

outside the waistband holster

- ◆ Reliable fixation of your weapon with the fastest possible access to it
- ◆ Level 2 retention holster
- ◆ Easily attaches to gear and allows for quick weapon position changes

Best suitable for: Police, Military, Special Forces



### POUCHES

inside & outside the waistband holsters

- ◆ Easily change your magazine in an emergency
- ◆ Variability of models and mountings

Best suitable for: Civilians, Bodyguards, Military, Police, Special Forces



## CANINE BEHAVIORAL SERVICE

### DOG TRAINING AND INSTRUCTORS EDUCATION

Selection, training, and further preparation of service dogs for various tasks, including detection of hazardous substances, protection of strategic objects, and guarding high-ranking figure

The largest material base of explosives and narcotics in Ukraine is used for the training of dogs, along with personnel with real combat experience. Moreover, trained dogs have proven themselves effectively during the war in Ukraine

These dogs also ensure the security of VIPs both in Ukraine and abroad



#### OUR EXPERTISE:



Sale of trained service dogs  
 • Explosive detectors  
 • Drug detectors  
 • Assault dogs



Advisory services  
 for use and training  
 of service dogs



Training of foreign  
 instructors to work  
 with service dogs



Providing a canine pair  
 (instructor and dog)  
 for contract work



Sale of puppies  
 of service breeds



Training service dogs  
 for territory protection



Sale of puppies  
 with further training

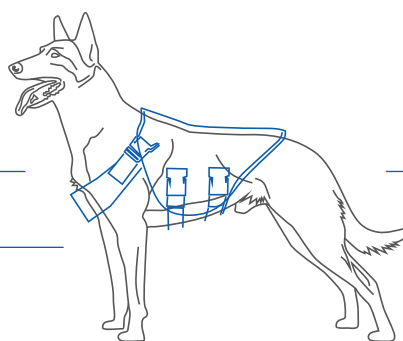

## BREEDS WE OFFER:



BELGIAN SHEPHERD (MALINOIS)



HOLLANDSE HERDER



GERMAN SHEPHERD



MIXES OF NAMED BREEDS

## KOZAK-2

### MRAP LIGHT ARMORED VEHICLE

KOZAK-2 is classic MRAP-type vehicle intended to perform a wide range of battle or auxiliary tasks:

- troop transporter
- command-and-control vehicle
- jamming vehicle etc.

KOZAK-2 is based on the all-wheel drive truck and distinctive feature is high internal volume that allows to carry variety of spacious equipment

KOZAK-2 has enhanced protection against mines and improvised explosive devices, which is achieved by a range of relevant design measures – high seating of the armoured vehicle (which provides a large distance from the crew seat to the epicentre of the explosion), a V-shaped bottom, a multi-layered floor and special mine-resistant seats



**LENGTH**  
7 150 mm

**GROUND CLEARANCE**  
350 mm

**SEATING CAPACITY**  
10 persons

**WIDTH**  
2 540 mm

**MAX SPEED**  
90 km/h

**GROSS WEIGHT**  
15 000 kg

**HEIGHT**  
2 720 mm

**BALLISTIC PROTECTION**  
STANAG level 2

**BLAST PROTECTION**  
STANAG level 3a/2b



# KOZAK-2M

## TACTICAL LIGHT ARMORED VEHICLE

KOZAK-2M is tactical armored vehicle intended for a wide range of combat missions, including actions directly on the battlefield. Its distinctive feature is ultrahigh off-road capability, comparable to 8x8 AFVs

KOZAK-2M is the next generation of the KOZAK-2 armoured vehicle, that has been the basic light armored vehicles for the Armed Forces of Ukraine and the National Guard of Ukraine in 2015-2022 years

The main design difference is that it is built in a load-bearing body with independent suspension (unlike KOZAK-2, which is based on the truck). This, combined with an ultra-high ground clearance of 430 mm and central wheel inflation, allows the vehicle to demonstrate outstanding off-road performance



**LENGTH**  
6 600 mm

**GROUND CLEARANCE**  
430 mm

**SEATING CAPACITY**  
8 persons

**WIDTH**  
2 565 mm

**MAX SPEED**  
115 km/h

**GROSS WEIGHT**  
14 000 kg

**HEIGHT**  
2 450 mm

**BALLISTIC PROTECTION**  
STANAG level 2

**BLAST PROTECTION**  
STANAG level 4a/3b



# KOZAK-5

## UNIVERSAL ARMORED VEHICLE

KOZAK-5 is armored utility vehicle, intended as for tactical tasks of low intensity, as for usage by police units and special operations forces. Its distinctive feature is high dynamic characteristics, particularly, road speed

KOZAK-5 is built on the Ford F550 chassis with increased payload suspension. Vehicle has several desing options, including choosing between single-compartment 8-persons version and 5-persons version with separate cargo compartment



Comparing with KOZAK-2 and KOZAK-2M armoured vehicles, the KOZAK-5 has simplified suspension design, but instead of it has very high dynamic performance due to its extremely high power-to-weight ratio

**LENGTH**  
6 660 mm

**GROUND CLEARANCE**  
300 mm

**SEATING CAPACITY**  
5 or 8 persons

**WIDTH**  
2 340 mm

**MAX SPEED**  
150 km/h

**GROSS WEIGHT**  
11 600 kg

**HEIGHT**  
2 520 mm

**BALLISTIC PROTECTION**  
STANAG level 2

**BLAST PROTECTION**  
STANAG level 2a/2b



## KOZAK-5 PML

### ARMORED UXO TRANSPORTING VEHICLE

KOZAK-5 PML is the special version of universal light armored utility vehicle KOZAK-5, intended designed for transportation of UXOs (digged out landmines, bombs etc) to places of its further disposal

Same as KOZAK-5, the KOZAK-5 PML is built on the Ford F550 chassis with increased payload suspension

KOZAK-5 PML has number of design measures to protect the crew in the event of UXO detonation during transportation, particularly, the sloping power wall, that deflects blast energy. Also the vehicle is equipped with some special mechanisms like automatized loading platform or spare wheel loading/uploading lift



**LENGTH**  
6 660 mm

**GROUND CLEARANCE**  
300 mm

**SEATING CAPACITY**  
2 persons

**WIDTH**  
2 340 mm

**MAX SPEED**  
150 km/h

**GROSS WEIGHT**  
10 200 kg

**HEIGHT**  
2 430 mm

**BALLISTIC PROTECTION**  
STANAG level 2

**BLAST PROTECTION**  
STANAG level 2a/2b



# OTAMAN 6X6

## ARMORED FIGHTING VEHICLE

OTAMAN is modern type of armored fighting vehicle. Due to its high level of ballistic and mine protection, OTAMAN can perform both combat missions on the battlefield and support functions)

OTAMAN is developed according to the latest trends in design of military vehicles of this type:

- front location of engine
- rear location of troops compartment
- high level of armor protection
- protection from landmines,
- substantive load capacity for installing of heavy equipment etc.

OTAMAN has flexible design, due to this, it can be produced in different modifications of various purpose. Furthermore, modularity of driveline allows to pass easily from 6x6 to 8x8 design, by request of the customer. The OTAMAN 6X6 version carries less troops, but is more maneuverable and can perform battle actions in urban terrains



 **LENGTH**  
7 220 mm

 **GROUND CLEARANCE**  
415 mm

 **SEATING CAPACITY**  
9-10 persons

 **WIDTH**  
2 904 mm

 **MAX SPEED**  
110 km/h

 **GROSS WEIGHT**  
23 000 kg

 **HEIGHT**  
2 295 mm

 **BALLISTIC PROTECTION**  
STANAG level 4

 **BLAST PROTECTION**  
STANAG level 3a/3b





# HORUNGY

## LIGHT ARMORED FIGHTING VEHICLE

HORUNGY is armored fighting vehicle of light class, intended for the variety of auxiliary tasks: personnel transporting, cargo transporting, command-and-command, electronic warfare and other non-combat activities

HORUNGY is manufactured using a number of USSR-time BTR-60 components, particularly, its lower part (bottom and suspension). All other parts are "made-from-scratch": new armor hull, multilayer floor, HVAC system, various special equipment etc.

Such technical solution imparts HORUNGY completely new qualities comparing with original BTR-60: significantly increased level of ballistic protection, full-fledged blast protection, wide functionality, higher firepower (in case of remote controlled weapon station installation)



**LENGTH**  
7 300 mm

**GROUND CLEARANCE**  
450 mm

**SEATING CAPACITY**  
11-13 persons

**WIDTH**  
2 950 mm

**MAX SPEED**  
85 km/h

**GROSS WEIGHT**  
13 600 kg

**HEIGHT**  
2 550 mm

**BALLISTIC PROTECTION**  
STANAG level 1+

**BLAST PROTECTION**  
STANAG level 2a/2b



# PILOT P4, P4.5, P5, P6, P6.5, P7, P8, P10, P12

## VERSATILE BOAT

Model that stands out for its extreme efficiency in various conditions and is especially suitable for search and rescue operations. Its lightness combined with excellent seaworthiness makes the boat ideal for quick response and performance of tasks in extreme conditions.

High load capacity, supplemented by inflatable sides, provides additional stability during maneuvering, which is especially important for mooring and quick evacuation



### PILOT P4

 **LENGTH**  
390 cm (12' 10")

 **POWER**  
30 HP max

 **PERSONNEL**  
6

### PILOT P4.5

 **LENGTH**  
450 cm (14' 9")

 **POWER**  
70 HP max

 **PERSONNEL**  
7

### PILOT P5

 **LENGTH**  
500 cm (16' 5")

 **POWER**  
100 HP max

 **PERSONNEL**  
8

### PILOT P6

 **LENGTH**  
580 cm (19' 0")

 **POWER**  
175 HP max

 **PERSONNEL**  
10

### PILOT P6.5

 **LENGTH**  
650 cm (21' 4")

 **POWER**  
200 HP max

 **PERSONNEL**  
12

### PILOT P8

 **LENGTH**  
780 cm (25' 7")

 **POWER**  
350 HP max

 **PERSONNEL**  
14/10

### PILOT P10

 **LENGTH**  
960 cm (31' 6")

 **POWER**  
700 HP max

 **PERSONNEL**  
16

### PILOT P12

 **LENGTH**  
1160 cm (38' 1")

 **POWER**  
900 HP max

 **PERSONNEL**  
18

These characteristics make **PILOT P7** indispensable for rescue and emergency medical services in water areas

### PILOT P7

 **LENGTH**  
695 cm (22' 10")

 **POWER**  
300 HP max

 **PERSONNEL**  
13



# TRIDENT T8

## BOAT

HD460M boat is designed for fast and efficient operations, performing a wide range of tasks in the military and law enforcement spheres.

### TRIDENT T8



**LENGTH**  
780 cm (25' 7")



**POWER**  
500 HP max



**PERSONNEL**  
14/10

### TRIDENT T8

The boat is ideal for combat reconnaissance, evacuation and maritime patrol, ensuring high reliability



RESCUE

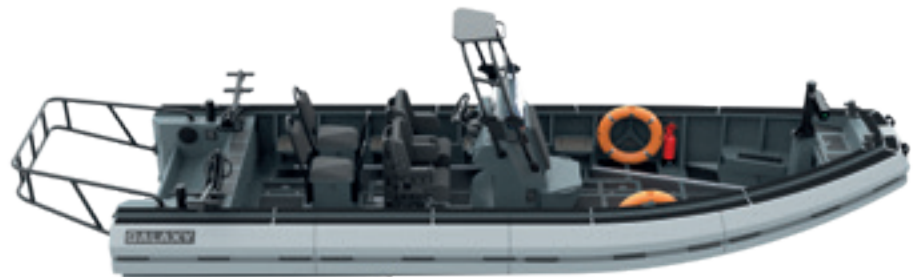

PATROL



MILITARY



## TRIDENT T12

### INNOVATIVE GALAXY BOAT

Designed for the most demanding operating conditions

It provides unprecedented reliability in heavy duty, law enforcement and commercial missions thanks to its heavy-duty aluminum hull construction and unique D-TUBE technology

The increased space in the cockpit allows for efficient placement of equipment and personnel while ensuring maximum productivity

#### TRIDENT T12



**LENGTH**  
1160 cm (38' 1")



**POWER**  
900 HP max



**PERSONNEL**  
18

#### TRIDENT T12

Combines modern technologies and well-thought-out ergonomics to perform the most difficult tasks



RESCUE

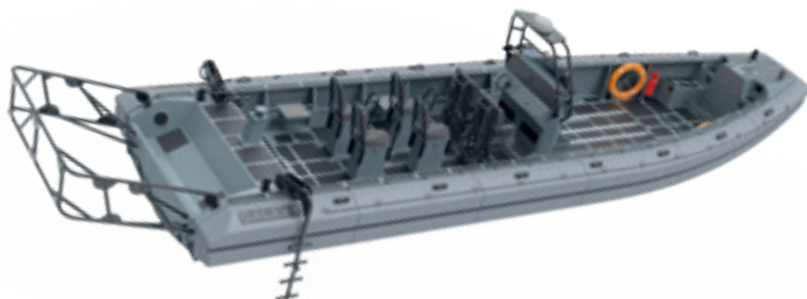

PATROL

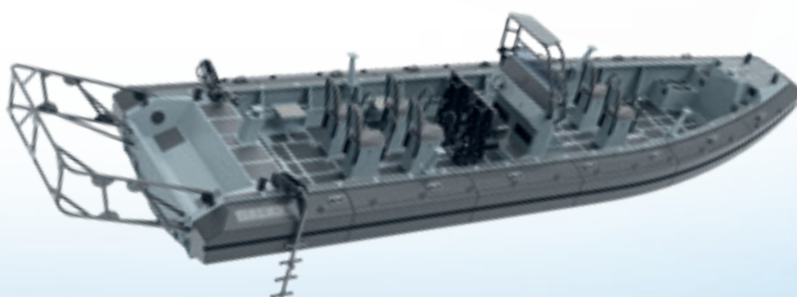

MILITARY



## HD460M

### BOAT

HD460M boat is designed for fast and efficient operations, performing a wide range of tasks in the military and law enforcement spheres



**LENGTH**  
470 cm (15' 5")



**POWER**  
50 HP max



**PERSONNEL**  
10



### HD460M

The boat is ideal for combat reconnaissance, evacuation and maritime patrol, ensuring high reliability



# VERSIBIONICS

## PROSTETICS

Versibionics are prosthetics and neurointerfaces that help people with limited abilities restore lost functions and expand their accessible environment. It is based on cutting-edge research and pure engineering thought

These prosthetic devices are created in collaboration with scientific centers and medical institutions to ensure that these products and developments are always at the highest level



### SENSORS AND DETECTORS

- ◆ 2-axis gyroscope and accelerometer
- ◆ Pressure sensors and vibrofeedback
- ◆ Temperature sensors



### ADDITIONAL DEVELOPMENTS

Proprietary development with NFC-tag



### SERVICE AND SUPPORT

Service center based on the production site



### CONSTRUCTION FEATURES

- ◆ Electric motors in each finger
- ◆ Modular fingers



### SOFTWARE

Proprietary software and neural network

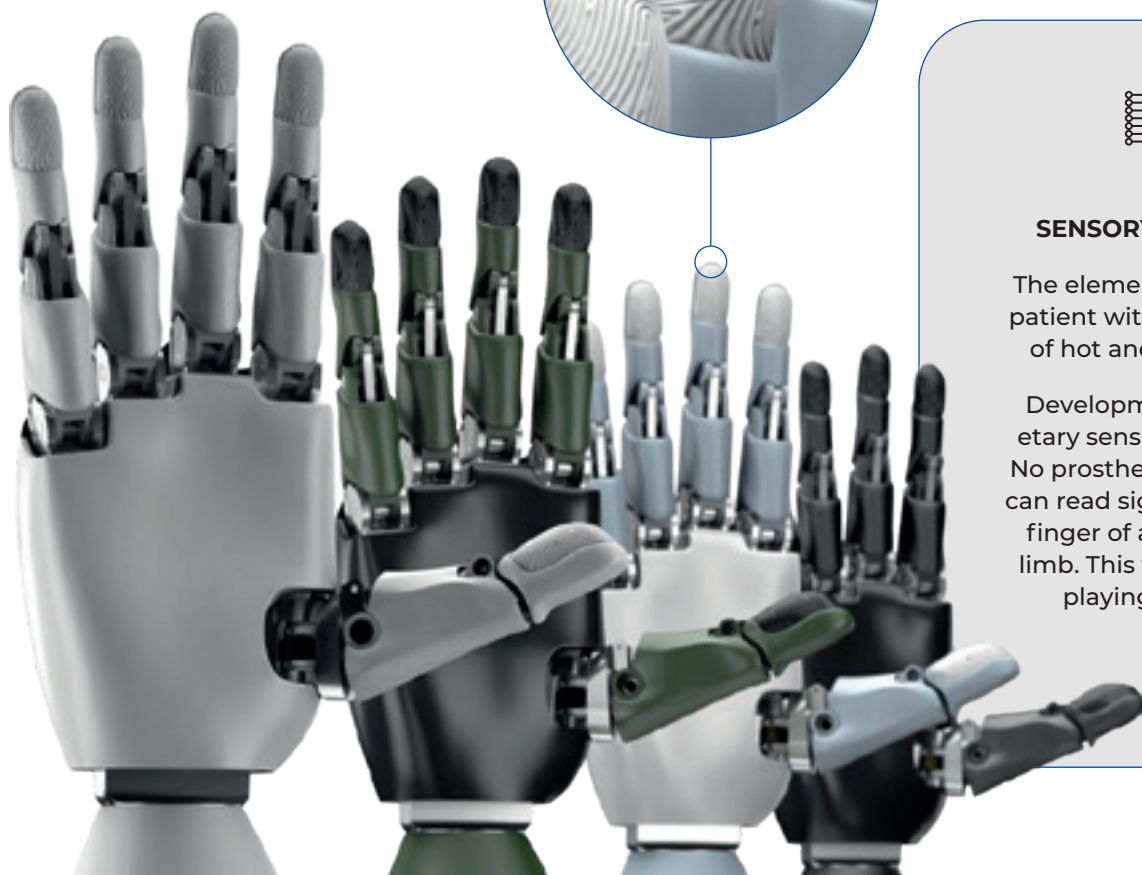
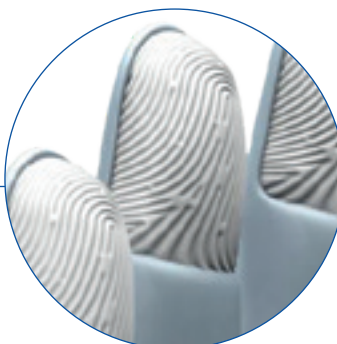

### SENSORY FEEDBACK

The element provides the patient with the sensation of hot and cold objects

Development of proprietary sensitive detectors. No prosthetic in the world can read signals from each finger of an amputated limb. This will even allow playing the piano

## KHARKIV 95

### HVAC EVAPORATOR 9,5 KW

The Kharkiv 95 HVAC Frontbox is an air conditioning system with ventilation and heating function and is an ideal choice for military vehicles and anyone who appreciates efficiency and high performance under any climate condition. It is specially designed to be used as the main unit of the vehicle's air conditioning and heating system. Thanks to its compact design and dashboard integration, it is suitable for various types of vehicles, ensuring efficient use of interior space



**NOMINAL COOLING POWER**  
9,5 kW



**WORKING VOLTAGE**  
12 or 24 V



**WORKING TEMPERATURE**  
from -35 to +40°C



**WEIGHT**  
10 kg



**HEATING POWER**  
11 kW



**EVAPORATOR'S CONTROL**  
manual / semi-automatic



**DIMENSIONS**  
555 x 260 x 455 mm



#### KEY FEATURES

- **Powerful** – Despite its compact size, the evaporator ensures an optimal cabin climate thanks to its power in both the cooling and heating function;
- **Versatility** – Easy to integrate into a variety of vehicles;
- **Reliability** – Manufactured from high quality components from leading global suppliers.

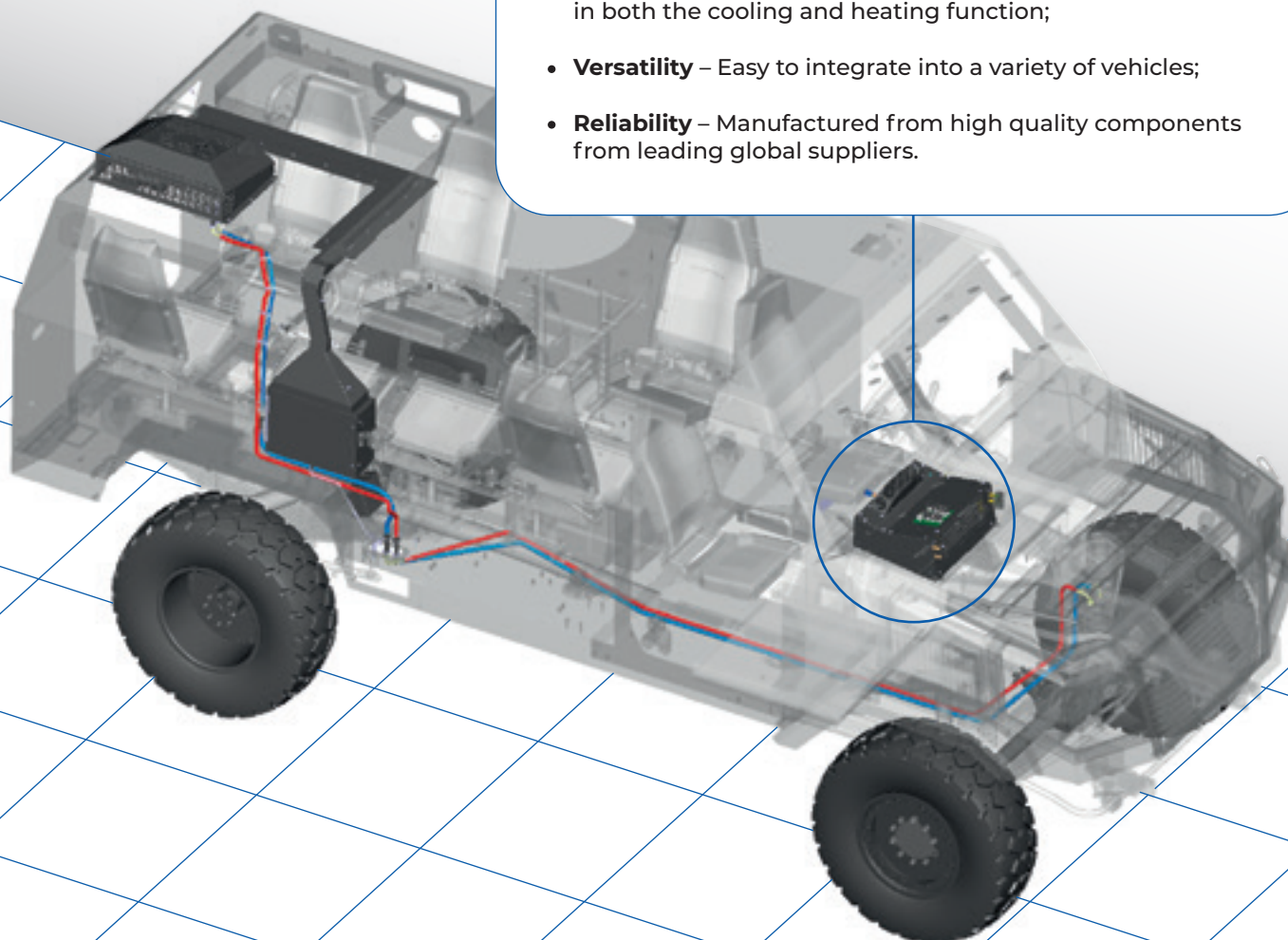

## KYIV 50

### AC EVAPORATOR 5 KW

The new Kyiv 50 universal evaporator is specifically engineered to meet the demanding requirements of military vehicle air conditioning applications. The Kyiv 50 sets a new benchmark for performance, reliability, and versatility in military vehicle climate control

With a cooling capacity of 5 kW and optional heating capabilities, the Kyiv 50 ensures optimal comfort for personnel operating in diverse environmental conditions. Designed to seamlessly integrate as an extension of the main vehicle AC unit, including on Ford F-series platforms, the Kyiv 50 delivers enhanced climate control without compromising space or efficiency



 **NOMINAL COOLING POWER**  
5 kW

 **HEATING POWER (OPTION)**  
5 kW

 **WORKING VOLTAGE**  
12 or 24 V

 **WORKING TEMPERATURE**  
from +10 to +40°C

 **DIMENSIONS**  
385 x 340 x 175 mm

 **WEIGHT**  
8 kg

 **EVAPORATOR'S CONTROL**  
manual / semi-automatic

#### KEY FEATURES

- **Compact Design** – Despite its powerful capabilities, the Kyiv 50 features a compact and space-saving design, making it ideal for installation in military vehicles;
- **Robust Construction** – Built to withstand the toughest conditions, the Kyiv 50 is constructed using high-quality parts sourced from leading global suppliers, ensuring reliability and durability;
- **Field Tested** – The Kyiv 50 has undergone rigorous field testing under the harshest circumstances to guarantee optimal performance and reliability in real-world military environments;
- **Easy Installation** – With its lightweight design and easy-fix connectors, the Kyiv 50 is quick and simple to install, minimizing downtime and maximizing operational readiness;
- **Customizable Solutions** – Thermo Project Ukraine offers customizable solutions to meet the unique needs of military customers, ranging from basic units to complete packages including installation material and air ducting.

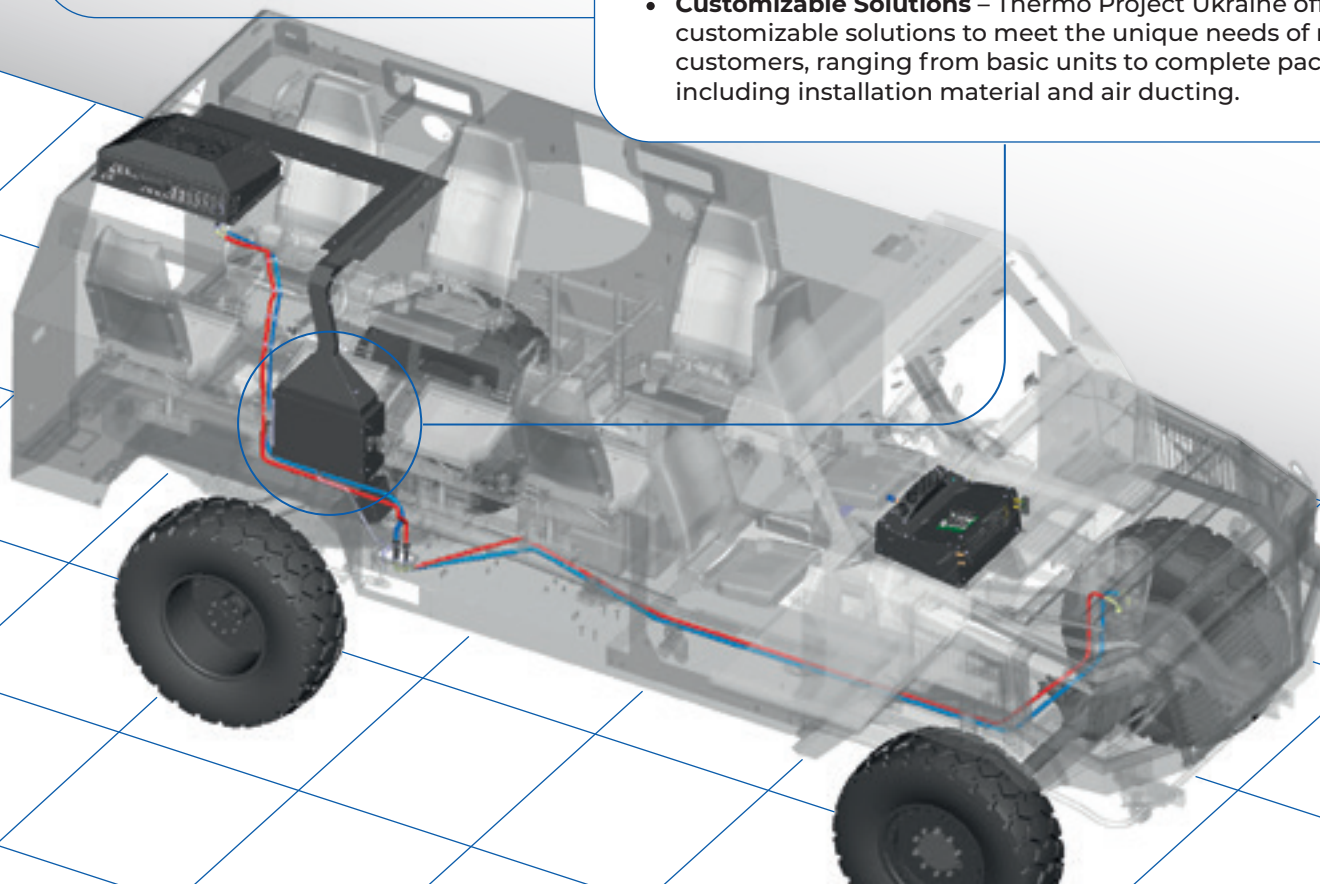



## ODESA 90

### UNIVERSAL HVAC EVAPORATOR

The Odesa 90 HVAC is an air conditioning system with ventilation and heating function and is an ideal choice for military vehicles and anyone who appreciates efficiency and high performance under any climate condition

It is specially designed to be used as the main unit or the secondary vehicle's air conditioning and heating system. Thanks to its compact vertical design it is suitable for various types of vehicles, ensuring efficient use of interior space



 **NOMINAL COOLING POWER**  
9 kW

 **HEATING POWER (OPTION)**  
11 kW

 **WORKING VOLTAGE**  
12 or 24 V

 **WORKING TEMPERATURE**  
from -35 to +40°C

 **DIMENSIONS**  
200 x 475 x 350 mm

 **WEIGHT**  
9 kg

 **EVAPORATOR'S CONTROL**  
manual / semi-automatic

#### KEY FEATURES

- **Powerful** – Despite its compact size, the evaporator ensures an optimal cabin climate thanks to its power in both the cooling and heating function
- **Versatility** – Easy to integrate into a variety of vehicles
- **Reliability** – Manufactured from high quality components from leading global suppliers

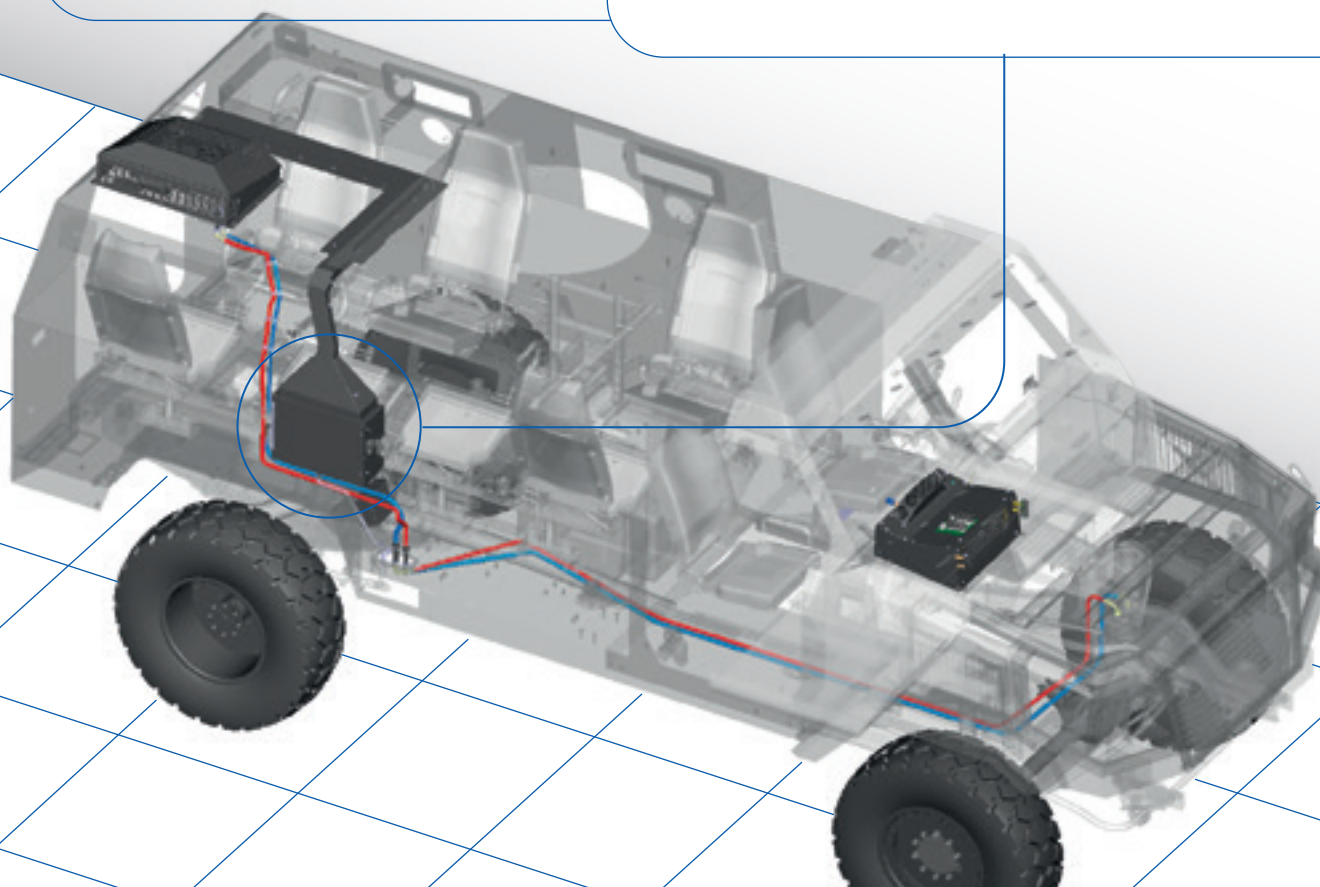



# GURT-M SYSTEM

**MODERNIZATION, MAINTENANCE, AUTOMATIC CONTROL AND DIAGNOSTICS SYSTEMS OF GUIDED HIGH-PRECISION WEAPON**

## THE MODERNIZED GURT-M SYSTEM ENSURES

- check and testing for the application of more than 50 various modifications of air missiles and guided air bombs
- specialized equipment, in addition to the AKPA, may also include diagnostic equipment sets (KDO) that allows pinpointing failures in missiles for their repairing. The missiles, for which the KDO are designed, are marked with red
- missile outgoing inspection at manufacturing plants
- failure diagnosis while missiles repairing
- forecast of missiles technical state while prolonging their service life



## SUPPORTED AIR MISSILES AND BOMBS



KH-59, KH-59M, KH-59ME



R-73K, R-73L, R-73E, U-73



KAB-500L  
KAB-500L-K  
KAB-500OD  
KAB-500KR  
KAB-500KR-U  
KAB-1500L-F  
KAB-1500L-PR  
KAB-1500KR



R-27R1, R-27ER1, R27T1, R-27ET1, R-27P, R-27EP, 470UT-RT, 470UT-ERT



KH-29T, IKH-29T, KH-29TD, IKH-29TD, KH-29L, IKH-29L, S-25L, S-25LD



KH-31A, KH-31A-UD



R-60M, R-60K, R-60MK



KH-31P (WITH L-111)  
KH-31P (WITH L-112)  
KH-31P (WITH L-113)  
KH-31P-UL(WITH L-111)  
KH-31P-UL (WITH L-112)  
KH-31P-UL (WITH L-113)



KH-25MP (WITH LO77M)  
KH-25MP (WITH LO15M1)  
KH-25ML (WITH 24N1)  
KH-25MR (WITH V500)  
KH-25MU (WITH LO77M)  
KH-25MU (WITH LO15M1)  
KH-25MU (WITH 24N1)



R-40T, UR-40T



R-40TD, R-40RD, R-40TD1, R-40RD1, UR-40TD, UR-40RD



R-33



R-33S



## EDM4S SKYWIPER

### HANDHELD ELECTRONIC DRONE MITIGATION SYSTEM

The SKYWIPER EDM4S is designed to counter Remote Piloted Aircraft Systems (RPAS) by mitigating control, video and navigation signals. Solution is fully mobile

All modules are integrated and ready to be used by activating trigger

#### RADIO MODULES

System is provided with radio modules for most popular RPAS control, video and GNSS frequencies\*:

- 900 MHz
  - GNSS L1 1.5 GHz
  - 2.4 GHz
  - 5.8 GHz
  - Custom frequencies on demand
- \*depends on local regulation rules

#### ANTENNA SPECIFICATIONS

System is provided with high gain directional antennas:

- 900 MHz
- GNSS L1 1.5 GHz
- 2.4 GHz
- 5.8 GHz



#### WEIGHT

less than 7 kg



#### BATTERY OPERATING TIME

up to 1 hour



#### CREW

1



#### DIMENSIONS

250 x 350 x 1045 mm



#### POWER

- System is provided with all required power supply equipment, cables, etc.
- Changeable batteries
- Integrated battery
- Additional (spare) batteries available

#### EQUIPMENT SET

- Robust rifle imitation frame
- High gain directional antennas
- RF modules
- Battery
- Holo sight/ scope



# SKYWIPER – OMNI

## MOBILE ELECTRONIC DRONE MITIGATION SYSTEM

The SKYWIPER OMNI is designed to counter Remote Piloted Aircraft Systems (RPAS) by mitigating control, video and navigation signals. Solution is fully mobile. All modules are integrated and ready to be used by pressing the button.

The device operates on a dome principle, providing omnidirectional protection



### RADIO MODULES

System is provided with radio modules for most popular RPAS control, video and GNSS frequencies\*:

- 900 MHz
- GNSS L1 1.5 GHz
- 2,4 GHz
- 5.8 GHz
- Custom frequencies on demand

\*depends on local regulation rules

### POWER

- System is provided with all required power supply equipment, cables, etc.
- Equipment can work from 3 different power supplies:
  - Integrated battery
  - 12 V external power supply
  - 220 V external power supply

### ANTENNA SPECIFICATION

System is provided with omnidirectional antennas:

- 900 MHz
- 9GNSS L1 1.5 GHz
- 2.4 GHz
- 5.8 GHz

### EQUIPMENT SET

- Robust Case with passive cooling
- Omni directional antennas
- RF modules
- Battery



**WEIGHT**  
11,3 kg



**CREW**  
1



**DIMENSIONS**  
340 x 300 x 215 mm  
(without antennas)



**BATTERY OPERATING TIME**  
up to 5 hours





## NOTA

### ELECTRONIC WARFARE SYSTEM

The NOTA system is designed to neutralize UAVs, disrupt mobile networks (GSM, UMTS, LTE, CDMA, Wi-Fi, VHF), countering signal and radar intelligence systems. The NOTA system provides direction finding of radio sources and radio jamming of wireless communication, channels of satellite navigation, remote control, telemetry, and technical intelligence means

The NOTA system is designed for military and civil applications. It can be adjusted to customer requirements (frequency band, emission pattern, power, etc.)

The operation Console of the system has a unified WEB interface (thin client) and allows the simultaneous work of several operators. The system can be used at airports, while certain frequencies for airborne radio communication or frequencies required for the safe landing of aircraft may not be muted. The required parameters are specified by the software



#### RANGE OF THE NOTA SYSTEM:

Ku frequency band	300-6200 MHz
Radio Intelligence Sector	Circular 360
Frequency range using directional and omnidirectional antennas	350-6150 MHz
Output power counteracting communication networks	450 W
Range using directional antennas	15 km
Range using omnidirectional antennas	5 km (counteraction to control channels), 15 km (GPS counter)
UAV counter-power output	385 W

#### DURING OPERATION OF THE SYSTEM NOTA DOES THE FOLLOWING:

- Detection of the UAV's operation
- Determination of UAV bearings
- Deactivation of satellite navigation channels in the frequency range NAVSTAR, GLONASS, GALILEO, GPS, BEIDOO
- Deactivation of remote control channels in the frequency range up to 6 GHz



#### DETECTION

not less than 20 km



#### CREW

2



#### COUNTERMEASURES TO THE UAV

not less than 20 km



#### WEIGHT

not more than 250 kg



#### DEPLOYMENT TIME

up to 20 minutes



# KOLCHUGA RDF-360

PASSIVE SURVEILLANCE SYSTEM/PASSIVE ESM TRACKER



### KEY FEATURES

- Passive surveillance, early warning, air defense missions
- Covert long-range precise real-time 3D geo-location
- Entirely covert operations, non-emitting capability
- Resilience to jamming and anti-radiation missiles
- Passive ESM Tracker (PET)
- Mobile/stationary configuration
- 4 units (1 central, 3 remote units)

### PASSIVE LONG RANGE ESM/ELINT

Frequency range	0.13 – 12 GHz
Instrumented range	up to 700 km
Geo-location method	AoA (angle of arrival)
DF accuracy	1.5 – 0.4°
Instantaneous bandwidth	0.5 GHz
Coverage sector	360°
Types of targets	land, air, naval
Processed signals	pulsed radar, CW, data links, jammers

### PASSIVE AIR EMITTERS TRACKER

Frequency range	8 – 18 GHz
Frequency sub-range	1.025 – 1.15 GHz
Instrumented range	up to 450 km
Geo-location method	TDOA (Time Difference of Arrival)
Tracking capacity	200 real time targets
Target library	100 000 (ICAO)
Tracking capability	3D
Instantaneous bandwidth	2.5 GHz
Coverage sector	360°
Types of targets	air (including VLO)
Processed signals	radars, IFF (1, 2, 3 (A/C), 4, 5, S, ASDB, TACAN)



## KOLCHUGA SDT-360

### PASSIVE SURVEILLANCE SYSTEM / AIR EMITTERS TRACKER

Kolchuga SDT-360 is designed for performing the following tasks: monitoring RF spectrum, receiving, measuring time-frequency parameters and analyzing signals, as well as accurately determining the coordinates and tracking air emitters in a 360° sector at a distance of up to 450 km

#### KEY BENEFITS

- entirely covert operations, non-emitting capability
- resilience to jamming
- resistivity to anti-radiation missiles
- mobile/stationary configuration
- 4 units (1 central, 3 remote units)

#### PASSIVE AIR EMITTERS TRACKER

Frequency range	8 – 18 GHz
Frequency sub-range	1.025 – 1.15 GHz
Instrumented range	up to 450 km
Geo-location method	TDOA (Time Difference of Arrival)
Tracking capacity	200 real time targets
Target library	100 000 (ICAO)
Tracking capability	3D
Instantaneous bandwidth	2.5 GHz
Coverage sector	360°
Types of targets	air (including VLO)
Processed signals	radars, IFF (1, 2, 3 (A/C), 4, 5, S, ASDB, TACAN)



# RPS-7 INHUL

## TACTICAL LEVEL DIRECTION FINDER

### SPHERE OF APPLICATION AND TASKS PERFORMED

- Monitoring and surveillance of RF spectrum in a coverage sector;
- Detection and DF of land and air emitters;
- Location RF emitters and displaying coordinates on a digital map (DF cluster);
- Generating a situational awareness picture and transmitting data to the central post

### TECHNICAL CHARACTERISTICS

Frequency range	0.8 – 18.5 GHz
Instrumental DF error (RMS)	3°
Surveillance sector	360°
Dynamic range	50 dB
DF method	AoA
Instant BW	500 MHz
Instrumental range	up to 50 km (LOS)
Roll-on/roll-off time	15 min
Continuous operation from an Autonomous power supply unit (power converter)	4 – 6 hours
Continuous operation from the mains	24/7
Total weight	50 kg

### FEATURES OF THE PRODUCT

- Compactness
- Mobility and ease of transportation (2-3 people)
- DF method - AoA
- Remote control of the equipment (radio, 4G modem, Ethernet, Starlink)
- Registration of detected signals, data storage and further technical analysis
- Recognition of radar types and determination of their modes of operation

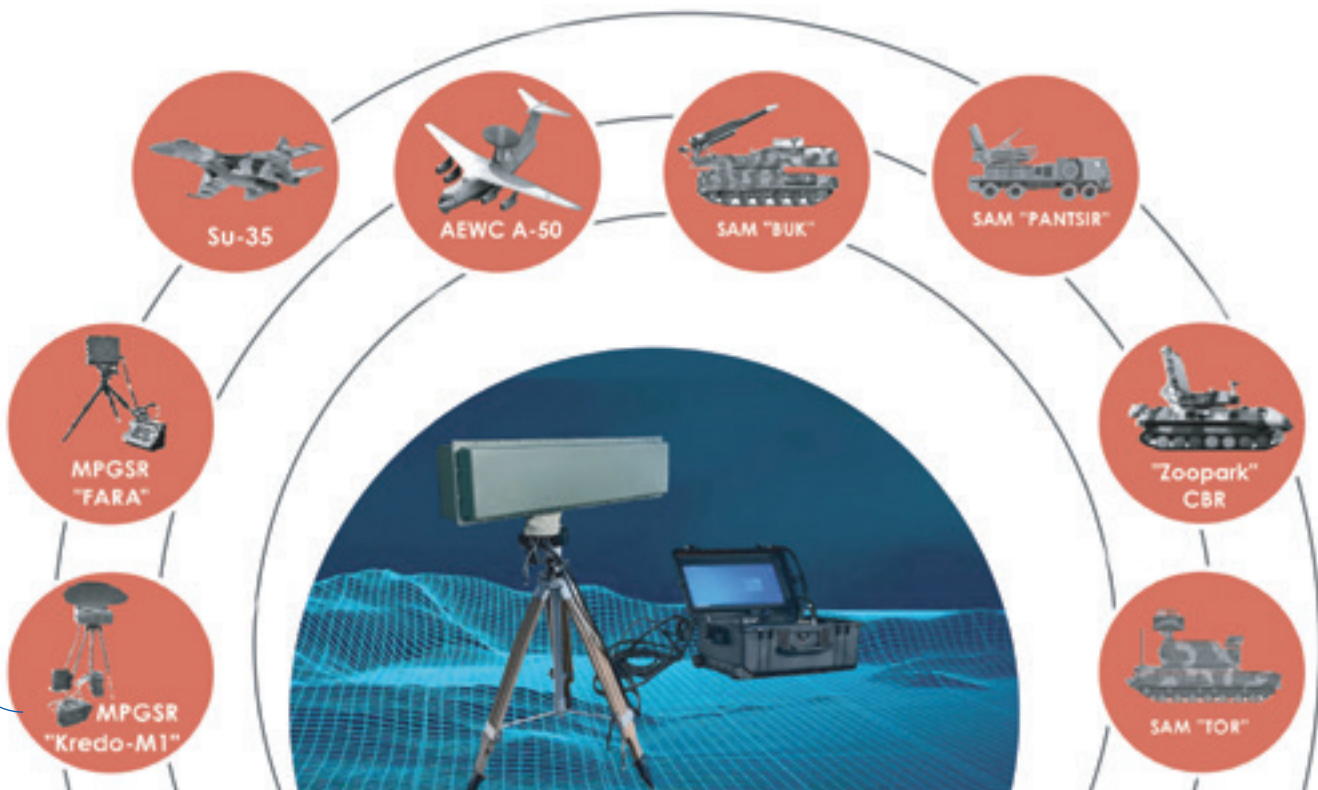





## 1L221E

### ARTILLERY TRACKING RADAR

The radar allows determining the coordinates of mortar firing positions, cannon artillery, rocket launcher systems, tactical missile launch positions at the first shot (launch). The radar provides coordinates of enemy positions and adjusts the firing of own weapons by automatic fire control systems

#### FEATURES

- Target detection and adjusting of artillery shooting
- Verification of firing system types: mortars, artillery, tactic missiles
- Using as an element of reconnaissance strike complex
- Operations in difficult climatic or jamming conditions

#### MAIN SPECIFICATIONS

Detection range:

artillery

23-28 / 28-29 km

mortars

20-24 / 25 km

MLRS

38-39 / 55-59 km

tactical missiles

55 / 58 km

Electronic scanning detector:

in azimuth

60° (± 30°)

in elevation

40° (+25° - -15°)



**FREQUENCY BAND**

S



**FIRE POSITIONS**

60 min



**ACCURACY**

0,35% from range



**DEPLOYMENT / CLOSING DOWN**

20 / 15 min



## 90K6E

### MOBILE 3D SURVEILLANCE RADAR

The mobile 3D air surveillance radar with a solid-state transceiver, intended for low, medium and high altitude flying targets detection. It is designed to be used:

- as target designation system in anti-aircraft missile troops
- as an information link in AD and AF units

The radar can be transported by C-130 Hercules aircraft



#### MAIN SPECIFICATIONS

Maximum radar operation limits:		Transmitter peak power	32 kW
in range	500 km	Clutter suppression	50 dB
in azimuth	360°	Jamming cancelling	20 dB
in elevation	0°-70°	Track throughput	more than 500
Detection range of target flight altitude 10-30 km	450 km	IFF equipment	built-in
		Transmitter type	Solid State





## BISKVIT-KB

### COUNTER-BATTERY RADAR

The Biskvit-KB radar is designed for radar reconnoitering of positions of mortars, multiple launch rocket systems, large-caliber artillery and provides automated transmission of radar data via communication channels to perspective Automated Systems and Automated Command Centers

The radar is performed based on a digital beam-forming (DBF) phased array.

Constructive solutions allow installing the radar on LAVs, conventional vehicles, or stationary objects



**FREQUENCY BAND**  
L-BAND



**ELEVATION RANGE**  
up to 40°



**DETECTION RANGE**  
up to 20 km



**AZIMUTH RANGE**  
360°



**WEIGHT**  
80 kg

#### DETECTION RANGE

120 mm mortar ammunition	7-8 km
81 mm mortar ammunition	4-5 km
MLRS ammunition	10-15 km
Howitzer	10 km

## MINERAL-ME

### MULTIFUNCTIONAL TARGET DESIGNATION RADAR SYSTEM

The Mineral-ME complexes of marine and coastal basis are the integrated multifunction information-and-control systems that are based on the usage of different information sensors (of active, passive, mobile surveillance posts) within one information field, provide the over-the-horizon detection of surface targets and deliver target designation data for full firing range of missile weapons



#### MAIN SPECIFICATIONS OF SUBSYSTEMS

Radar type	Active	Passive	MEI-MOR	
Frequency band	I	I, G, E/F, D	I	
Scanning zone	through azimuth through range	360° 35 (100-250) km	360° up to 450 km	360° up to 30 km

# P-12, P-14, P-18, P-19, P-37 MODERNIZATION

## SOLID STATE VHF RADAR

### POSSIBILITIES AND ADVANTAGES:

- High detection range, accuracy, jamming immunity, numbers of plots and tracks, reliability
- High dynamic range (up to 100 dB) resulting in high jamming immunity and suppression of clutter and weather formations
- Implemented functions of a radar extractor for post-detection signal processing (detection, location measuring, plots generation, clutter map, scan-to-scan processing, stabilization of false target generation, processing of identification signals, data distribution to consumers)
- A large number of probing signals, ability to choose the best one depending on the air situation, jamming and combat conditions
- Reconfigurable (via program or random) parameters of probing signal — working frequency, modulation type, waveform
- Efficient algorithms for clutter suppression with a wind speed compensation the automatic combining of amplitude and coherent channels that decrease signal loss and increase detection range and accuracy implementation of an automatic built-in diagnostic system



Frequency band	140-180 MHz
Radar coverage zone, max zone	up to 500 km
Location accuracy:	
range	200 m
azimuth	0,4°
Resolution:	
range	1200 m
azimuth	8°

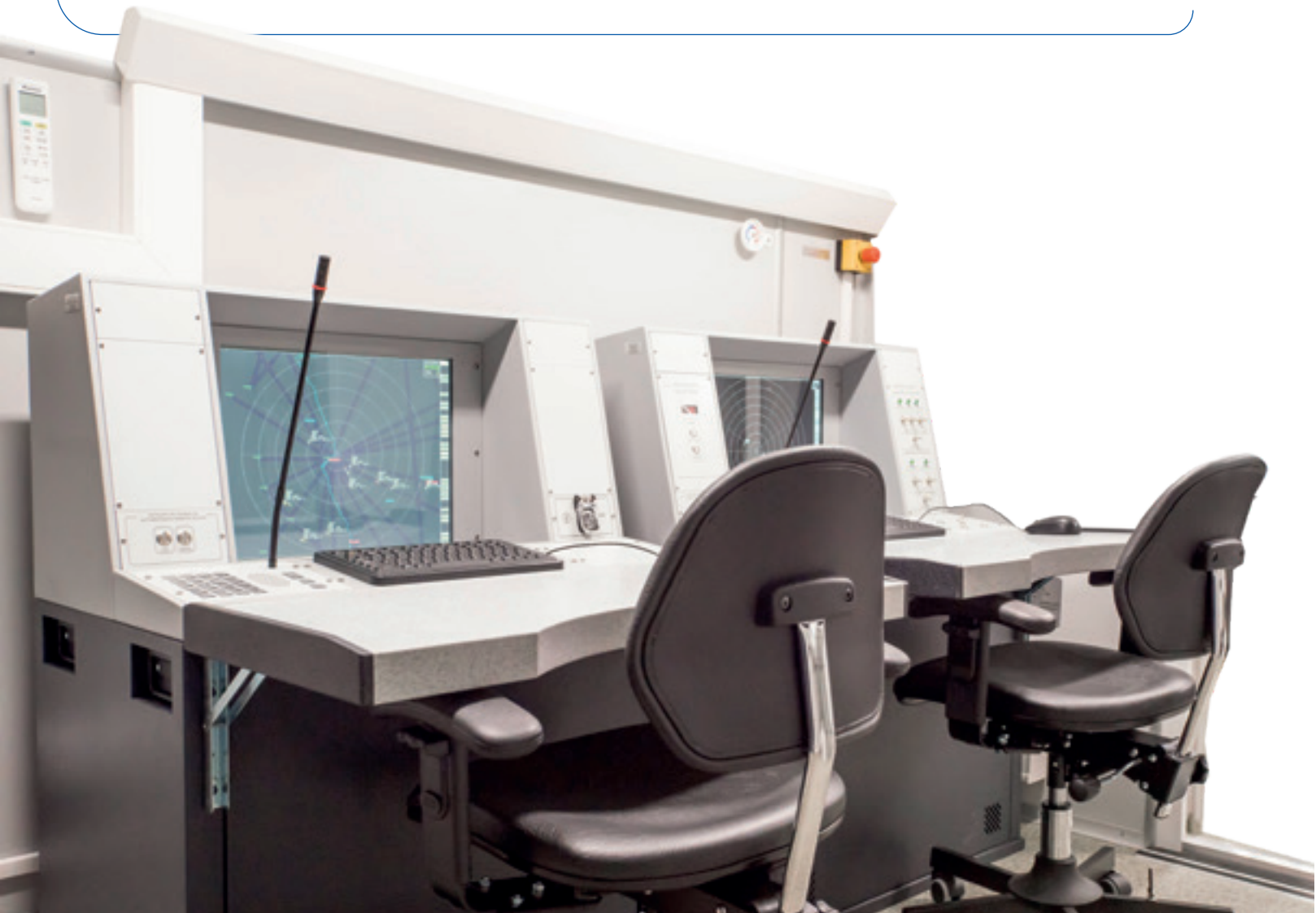



## DELTA

### MOBILE SOLID-STATE ALL-ROUND OBSERVATION 2D RADAR FOR NAVAL APPLICATIONS

The DELTA radar is a modern mobile two-dimensional pulse coherent solid-state radar for surface and air surveillance with low probability interception of its electromagnetic radiation. It delivers in a fully automatic way the current coordinates of any target located within its area of detection. This mobile radar could be installed on transport vehicles (automobiles, armored personnel carriers, infantry combat vehicles, etc) which allows arranging its operation in uplands to ensure necessary viewing conditions

#### DETECTION RANGE

Antenna rotation	3, 6, 12 s
Power supply	220 W, 50 Hz
Power consumption	not more than 500 W
Equipment weight	150 kg
Maximum target detection range:	
small size air type	8-20 km
ground-based	16-20 km
surface type	radio horizon range



#### FREQUENCY BAND

X



#### NUMBER OF TARGETS TRACKED

up to 50



#### BANDWIDTH

150 MHz



#### RANGE SCALE

12, 24, 48, 96 km

## ROSA

### COHERENT-PULSE SOLID-STATE SURVEILLANCE RADAR

The Rosa Radar is a modern marine coherent-pulse, solid state, two coordinate all-around surveillance radar, which is intended for the surveillance after the on-land, surface and air situation in the area of responsibility. Radar construction allows to place it on board of a corvette, frigate etc. It can be used as:

- autonomous surveillance radar
- element of an integrated system for information collecting, processing, and ship weapon control

#### MAIN SPECIFICATIONS

Maximum detection range (of airborne targets with the fly altitude of 1000 m)	
- with RCS>10 m <sup>2</sup>	≥100 km
- with RCS>2 m <sup>2</sup>	>45 km

Maximum detection range of anti-crafts with RCS>0.05 m <sup>2</sup> with the fly altitude >5m	>12 km
---	--------

Number of tracked targets	up to 50
---------------------------	----------



#### FREQUENCY RANGE

S



#### PEAK-PULSE POWER

up to 1500



#### READINESS TIME

up to 2 m



#### RANGE SCALE

25, 50, 100, 200 km

# 36D6-M2

## HIGH-MOBILITY SURVEILLANCE RADAR

The high-mobility surveillance radar is intended for detection and target identification at the low and high height at the influence of active and passive jamming with the coordinate and tracks data output



**OPERATION BAND**  
S



**NUMBER OF TRANSPORT UNITS**  
2



**INSTRUMENTED RANGE**  
90, 180, 360 km



**DEPLOYMENT / CLOSING TIME**  
<30 min



**ANTENNA TYPE**  
DPAR



Detection range for low flying targets	RCS = 1-2 m <sup>2</sup>	Track capability	>256
at flight altitude 100 m	42 km	Accuracy, range	100 m
at flight altitude 1000 m	110 -115 km	Accuracy, azimuth	10 – 15 angular min
Azimuth coverage	360°	Accuracy, altitude	400 m AT < 70 km range
Elevation coverage	0,5° – 30° in 2 rev.	MTBF	800 hours
RPM	>48 dB		





## PRV-16MA

### HEIGHT FINDER UPGRADE

Mobile Height Finder PRV-16MA is a mobile jam-protected centimetric pulse radar

Designated for detection, coordinate determination (azimuth, range, height), when operated independently or through Extractor A1000-H, ensures automatic and semi-automatic height measurement for targets with a coordinate designation from P-140MA, P-180Y, P-190Y radars

Data exchange between Radar and PRV is conducted via PS-232C Interface

PRV-16MA is protected from the interference of various obstacles:

- Against local object clutter and passive jamming – MTI System
- Active jamming (noise, pulse) and non-synchronous jamming – frequency tuning capability



**OPERATION  
FREQUENCY RANGE**  
Centimetric



**AVERAGE POWER**  
300 W



**MAXIMUM RANGE**  
300 km



**SWITCH-ON TIME**  
5 min



**CONSUMED POWER**  
no more than 30 kW

### DETECTION RANGE

for Targets with SCS = 1 m<sup>2</sup> and with P=0.5

HTARGET (500 m)	no less than 65 km
HTARGET (4000 m)	no less than 220 km
HTARGET (6000 m)	no less than 250 km

### OPERATIONAL CONDITIONS

Relative Humidity  
98% at t = 25°C

Maximum Altitude  
above Sea Level

### RESOLUTION

Range	75 m
Azimuth and Elevation	0.5°
Clutter Suppression Ratio	7X

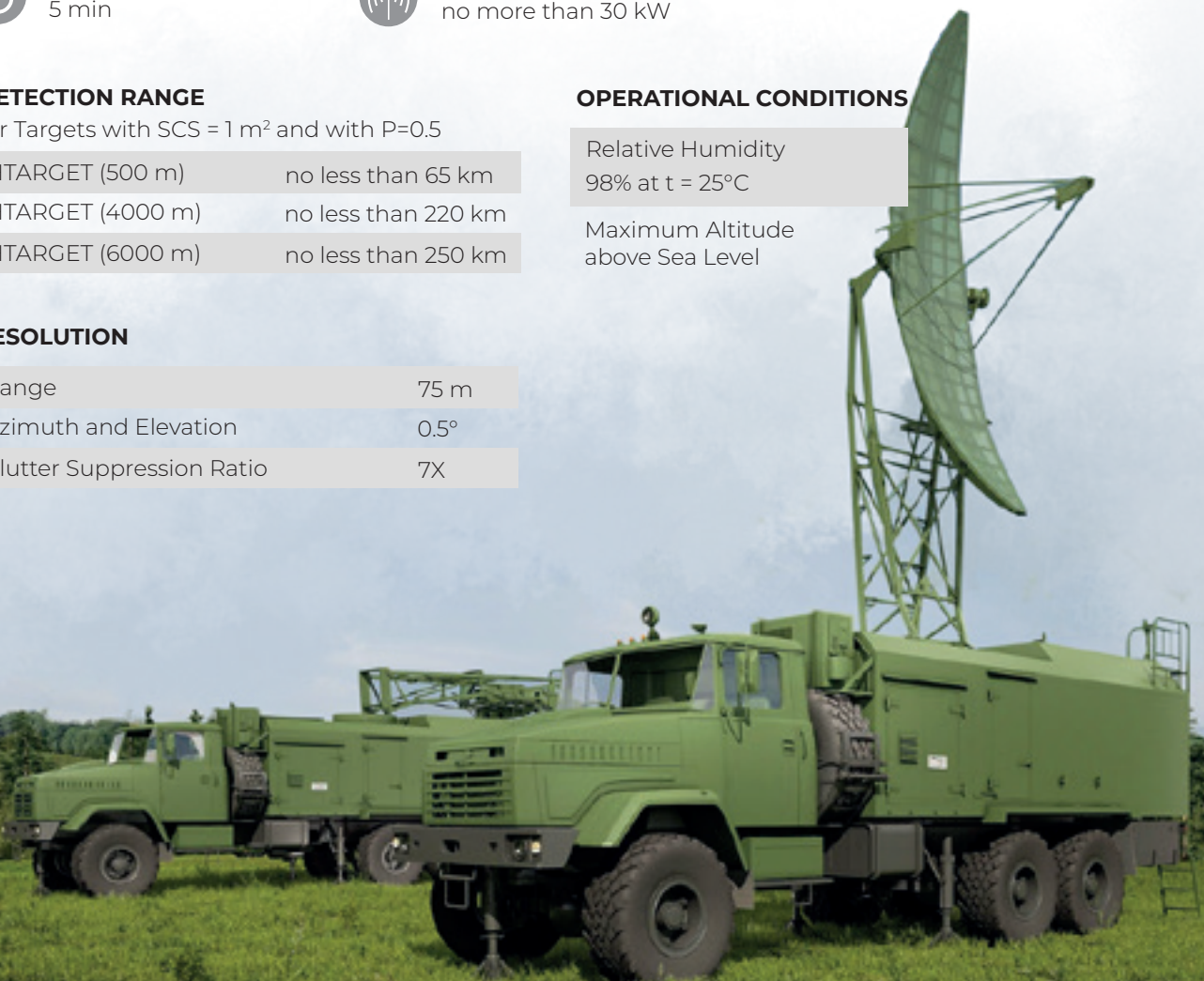

## ASR-23L

### AERODROME RADAR

ASR-23L Airport surveillance radar is designed to survey and control the airspace in the airfield area

The ASR-23L combines primary and secondary channels as well as a side-lobe suppression channel to improve detection performance. The primary channel of ASR-23L operates in the L band (ICAO), the secondary channel uses standard RBS frequencies



#### OPERATING FREQUENCIES RANGE

**PSR:** 1250-1350 MHz

**SSR:** 1030 MHz (interrogation)  
1090 MHz (response RBS)



#### TRANSMITTER PULSE POWER

**PSR:** 4kW

**SSR:** 1kW



#### DETECTION RANGE OF THE TARGET WITH RCS=2,5 M<sup>2</sup>, P=0,5

MIN RANGE

**PSR:** 1000 m

**SSR:** 2.5 km

MAX RANGE

**PSR:** 100 km

**SSR:** 220 km



#### RESOLUTION

BY RANGE

**PSR:** 250 m

**SSR:** 150 m

BY AZIMUTH

**PSR:** 5°

**SSR:** 5°



#### POWER CONSUMPTION

< 10KW

#### CAPABILITY

- The radar implements automatic tracking of the trajectories of airborne objects. ASR-23L provides data receipt from other radars, exchange of radar information occurs via the provided data exchange channels in the agreed exchange protocol
- Only solid-state components are used in the transmitting and receiving equipment of the radar. The transmitter is built on a modular basis and provides a passive failure - failure of a separate module leads only to partial longitudinal decalage of the radar parameters
- The radar is designed for round-the-clock operation and is equipped with an uninterruptible power supply that ensures the operation of the radar for up to 10 minutes in the event of a power failure
- The air situation is automatically documented, providing the ability to reproduce the documented data in passive and interactive modes
- The ASR-23L has credible protection against impulse and active noise interference. The interference situation is presented on the operator's screen







## KHORTYTSIA-M

### MOBILE COMINT COMPLEX

Mobile comint complex is designed for automated detection, demodulation, decoding, recording, storage, and analysis of complex signals in the operating frequency range, direction finding, real-time transmission of radio signals, including with FHSS signals. Able to work autonomously or control the operation of other comint facilities as part of comint network



#### MAXIMUM ANALYSIS BANDWIDTH

80 MHz



#### SINGLE FREQUENCY DYNAMIC RANGE

≥ 80 dB



#### FHSS SIGNALS

Search, direction finding, demodulation



#### OPERATING FREQUENCY RANGE

25-6000 MHz



#### SCANNING SPEED

60 GHz/sec



#### NUMBER OF INDEPENDENT CHANNELS

5



#### APPROX. EFFECTIVE RANGE

45 km

Number of radio networks for processing in scan mode

up to 4096

Scanning speed of the frequency bank in scan mode (except networks with fhss)

over 100 frequencies/sec



## VHF COMINT STATION

### MAIN ADVANTAGES

- automatically identifies and demodulates analog communication signals using AM, FM, USB and LSB modulation
- automatically identifies, demodulates and decodes signals of radio stations of digital communication systems DMR, TETRA, dPMR, NXDN, ACPO25 and ACARS
- decodes selective call systems DTMF, CTCSS, SelCall



### MAIN SPECIFICATIONS

Operating frequency range	25 – 6000 MHz		
Panoramic channel frequency band	40 MHz		
Number of panoramic channels	4	8	16
Simultaneous viewing band	160 MHz	320 MHz	640 MHz
Number of simultaneously intercepting signals	256	512	1024
Dimensions	62x72x45 cm	62x72x50 cm	2x62x72x50 cm
Weight	35 kg	45 kg	2x45 kg
Power consumption	450 W	550 W	1100 W

### THE STATION INCLUDES:

- antenna-feeder system with a telescopic mast
- radio receiver
- control servers with additional equipment in a shockproof case
- DMR decoding module (optional)
- operator workstations based on a laptop

## VHF COMINT AND DF STATION

### MAIN SPECIFICATIONS

Operating Frequency Range	25 - 6000 MHz
Amount of broadband panoramic reception channels	4
Immediate overview band of broadband reception channel	40 MHz
Complex's immediate overview band	160 MHz
Amount of permanent surveillance channels	up to 256
Instrumental directionfinding error <ul style="list-style-type: none"> <li>· in 25 - 100 MHz range</li> <li>· in 100 - 700 MHz range</li> <li>· in 700 - 6000 MHz range</li> </ul>	<ul style="list-style-type: none"> <li>≤ 20</li> <li>≤ 1,50</li> <li>≤ 30</li> </ul>
Minimal signal duration	1 ms
Among of direction findings per second	up to 20



### THE STATION CONSISTS OF:

- direction finding antenna-feeder system
- radio receiver with a direction finding unit
- control servers in a shockproof case
- DMR decoding module
- operator workstations based on a laptop



## VHF MOBILE SIGINT STATION

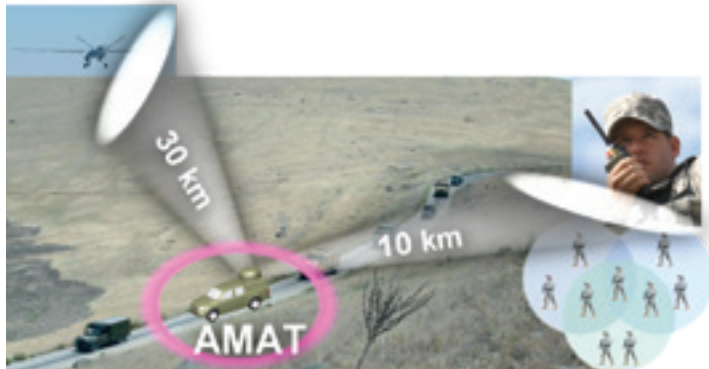

The station is designed for radio reconnaissance of forward-based enemy communications equipment, as well as detection of reconnaissance and strike types UAVs

### MAIN ADVANTAGES

- automatic detection of signals from VHF range communication equipment and UAVs both from a stationary position and in motion
- automatic classification of detected communication means: analog, digital radio stations, UAVs, etc.
- determination of the direction to the identified sources of radio emission with display on maps of the area
- automatic interception, decoding and directionfinding of all communication sessions with AM, FM, USB and LSB modulation
- automatic interception, decoding and directionfinding of all communication sessions (100+) digital communication systems such as DMR, TETRA, dPMR, NXDN, ACPO25 and ACARS.
- listening to conversations, displaying current direction and vector of movement of subscribers and UAVs on electronic maps terrain.

## COMPLEX FOR DETECTING AND COUNTERING UAVS

The complex includes subsystems for identifying and countering

### The UAV detection subsystem includes:

- SIGINT station in the range 0.2 - 6 (12) GHz
- radar (millimeter and centimeter ranges), designed to detect UAVs
- station for detecting optoelectronic devices.

### The UAV countering subsystem includes:

- electronic countermeasures control command and data transmission channels
- electronic countermeasures signals of satellite navigation systems
- system jamming means of optoelectronic reconnaissance with visible and infrared ranges, installed on the UAV



### MAIN ADVANTAGES

- UAV detection, identification and counteraction is carried out automatically
- Integration into an automated combat control system for the purpose of automatic notification and target designation
- One of the main advantages is the survivability of the complex, which is achieved by duplication and spatial separation of active and passive components



## CYBERSECURITY TRAINING PROGRAMS

### CYBER & NETWORK SECURITY

#### TRAINING COURSE

Development of educational material

Introducing the program interface, basic functions and practical knowledge application

Demonstration of the capabilities and application of specialized software using real examples

Development of practical tasks for participants, including the use of specialized software

Results grade of completed tasks and feedback for participants

Analysis of real-life cases in which specialized software use is necessary



### ELECTRONIC WARFARE

#### TRAINING COURSE

1. The role and place of electronic intelligence in modern warfare strategy

2. Automation of the process of collection, analysis and delivery of intelligence information to end-users

3. The main characteristics of modern electronic reconnaissance

4. Utilization of means providing automatic detection, identification and location of enemy radio-electronic means

5. Real-time display of the location of radio communication facilities on electronic maps

6. Revealing enemy groups and continuous real-time surveillance

7. Targeting radio sources for destruction or electronic attack

8. Methods and tactics of radio-electronic suppression of enemy radio-electronic means

9. Types of drones used in modern conflicts

10. Anti-drone warfare

11. Drone detection methods

12. Drone suppression techniques

13. Drone destruction techniques

14. General principles of building anti-drone countermeasures systems

15. Typical structure, functions and tasks of a brigade's electronic reconnaissance system

16. Analyzing the main types of radio-electronic means from the point of view of electronic reconnaissance

17. Tactical commercial communications equipment

18. Tactical military communications

19. Telecommunication networks

20. Satellite communications systems

21. Radar stations

22. Sea-based airborne assets

23. Airborne on-board facilities

24. Electronic warfare systems

25. Analyzing the main types of electronic reconnaissance equipment





## CICONIA

### UAV COMPLEX

CICONIA is a complex of autonomous remote-controlled UAVs, designed for various tasks such as aerial reconnaissance, patrolling, area mapping with the possibility of online information transfer, and obtaining accurate geographical coordinates in real-time mode. Included autonomous flight. Operation in difficult weather conditions

### AREA OF APPLICATION:

- Aerial reconnaissance
- Adjustment of artillery fire
- Border surveillance
- Automation and troop control
- Mapping

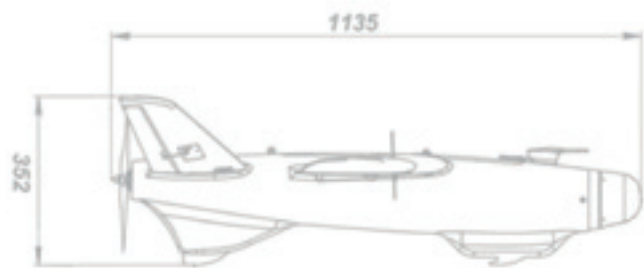

**POWER UNIT**  
electric



**TEMPERATURE RANGE**  
from -20 to +55 °C



**TAKEOFF WEIGHT**  
5,5 ± 0,3 kg



**CRUISE SPEED**  
60-70 km/h



**WIND RESISTANCE**  
up to 20 m/s



**FLIGHT TIME**  
2-2,5 h



**MAX FLIGHT ALTITUDE**  
1500 m



**OPERATING RANGE**  
100 km



**DIMENSIONS**  
1980 X 352 X 1135 mm



# RAYBIRD 3

## UNMANNED AERIAL SYSTEM

Small unmanned aerial system for different long-range missions, ISTAR solutions, and SAR applications.

Man-portable (one-box) system ready to be deployed in minutes. The modular flying platform allows the changing of various function modules easily. Payload packages can alternatively include radio relays and electric warfare/countermeasure equipment.

Vertically integrated design and production processes allow us to manufacture systems to the client's needs. This also provides top-notch maintenance during UAS exploitation and enables modifications as client's needs evolve



**TAKEOFF WEIGHT**  
21 kg



**CRUISE SPEED**  
120 km/hour



**LAUNCH METHOD**  
from the catapult



**MAX FLIGHT ALTITUDE**  
3000 m



**OPERATING TEMPERATURE**  
from -20°C up to +45°C



**METHOD OF LANDING**  
on a parachute



**FLIGHT TIME**  
more than 24 hours



**OPERATING RANGE**  
video link — up to 140 km  
in aut. mode — 2500 km



**WINGSPAN**  
2,9 m





## GOR

### ISR UAV

The GOR unmanned aerial system is a ready-made solution for performing reconnaissance and surveillance tasks

The complex is equipped with a camera with a thermal imager and encrypted communication



**TOTAL RANGE OF FLIGHT**  
150 km



**CRUISE SPEED**  
64 km/h



**MAX SPEED**  
108 km/h



**PAYLOAD**  
1,2 kg



**MAX TAKEOFF WEIGHT**  
11 kg



**FLIGHT ALTITUDE**  
3500 m



**FLIGHT DURATION**  
up to 2,5 hours



**DIMENSIONS**  
1612 x 160 x 496 mm



**WINGSPAN**  
2645 mm



### COMMUNICATION SYSTEM OF THE GOR UAV

The communication system for unmanned aerial vehicles can operate in the frequency bands 433, 2000 – 2700 MHz

This communication system is an EW-protected system that can ensure the reliability and security of communication during UAV flight

The range of a stable video link, with direct radio visibility, depends on the antenna system and can be up to 50 km

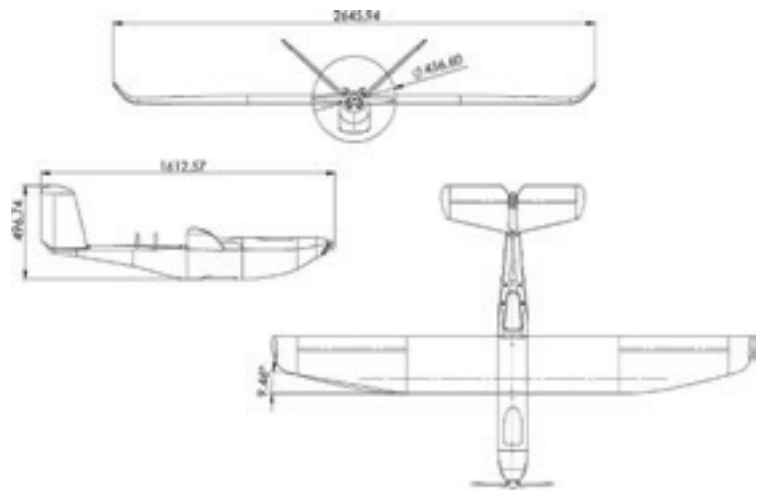

### PAYLOAD – DIGITAL CAMERA OF VISIBLE AND INFRARED RANGE

The NextVision Raptor camera is a state-of-the-art, high-tech device designed for long-range imaging

With its lightweight design and dual EO-IR stabilization, it provides a reliable, high-quality imaging solution for challenging environments



### MAIN CAMERA

Visible 400-700 nm  
Resolution: 1280 x 720  
Zoom : x40 + x2 digital, total x80 continuous zoom  
HFOV : 60° WFOV – 1.5° NFOV – 0.75° DFOV

### THERMAL CAMERA

LWIR uncooled 8-14 nm  
Resolution : 1280 x 720  
Zoom : x8 digital, continuous zoom  
HFOV : 17.5° W.FOV - 2.2° D.FOV

# CETUS

## UNMANNED AERIAL SYSTEM

The Cetus UAV System is designed for high-quality, high-resolution aerial imagery over large areas and distances

A feature of Cetus is a fully automatic flight from start to landing which can be done in conditions of active electronic interference. Cetus successfully performs tasks even in the absence of communication with the ground station and complete suppression of GNSS satellites. The flight is low noise and can take place at high altitudes. Flight without communication with the ground station can not be intercepted by the enemy, it is also impossible to determine the location of the crew



All Cetus images are well-targeted and geo-referenced due the high precision jamming protected GNSS receiver on board. Thus, it is possible to quickly combine them into an orthophoto. The technology of fast creation of operative orthophotos in field conditions is developed

**OPERATING RANGE**  
up to 120 km

**MAX SPEED**  
110 km/h

**WEIGHT**  
4,8 kg

**FLIGHT ALTITUDE**  
100 – 2000 m

**CRUISE SPEED**  
65 km/h

**WINGSPAN**  
2700 mm

**MAX FLIGHT TIME**  
up to 2 h

**MAX TAKEOFF WEIGHT**  
9 kg

**LENGTH**  
1200 mm



**CAMERA**  
61 MP 5 cm GSD





## OBSERVER-S

### UNMANNED AERIAL SYSTEM

Observer-S is a multi-purpose complex of aerial surveillance and photo/video recording based on a multifunctional unmanned aerial vehicle, which allows you to perform automatic flight along a given route using automatic take-off/landing modes

The UAV can take off and land in automatic and manual mode

Unique patch antennas with a high level of signal amplification provide an advantage in the use of low-power radio and video signal transmitters. The radio telemetry and control channel is encrypted using a 128-bit AES key, which makes it impossible to intercept information and control the aircraft

A secure laptop computer serves as the ground control station



**OPERATING RANGE**  
up to 160 km



**SPEED**  
32 – 125 km/h



**HEIGHT**  
530 mm



**DATA TRANSMISSION RANGE**  
60 km



**OPERATING TEMPERATURE**  
from -15 to +50°C



**WINGSPAN**  
3870 mm



**FLIGHT ALTITUDE**  
200 – 3000 m



**MAX TAKEOFF WEIGHT**  
8,2 kg



**LENGTH**  
1980 mm



**MAX FLIGHT TIME**  
up to 3 h

## NEMESIS

### UAV COPTER-BOMBER

The Nemesis UAV is designed for delivery of munitions to enemy targets, destruction of armored vehicles, and enemy personnel

More than 200 tanks and other armored vehicles have been damaged, as well as 100 military stationary objects. Over 600 combat missions have been completed



**OPERATING RANGE**  
up to 12 km



**PAYLOAD**  
up to 10 kg



**FLIGHT ALTITUDE**  
up to 1000 m



**MAX SPEED**  
70 km/h  
(with max payload)



**CRUISE SPEED**  
55 km/h  
(with max payload)



**FLIGHT DURATION**  
up to 43 min



**TARGETING SYSTEM**  
operator-controlled  
via video imagery

# PUNISHER

## UNMANNED AERIAL COMBAT SYSTEM

Punisher is a high-precision alternative due to a lack of long-range artillery or missile weapons for destruction of enemy targets at distances of 25 / 30 / 35 / 40 / 45 km. The system allows to destroy targets from the "first shot". Punisher has a predicted localization of impact. Due to its characteristics, it minimizes the risk of possible losses among non-combatants



**OPERATING RANGE**  
45 km



**PREPARE TO START**  
15 min



**FLIGHT ALTITUDE**  
400 m



**MAX SPEED**  
180 km/h



**RELOAD**  
3 min



**WIND RESISTANCE**  
up to 25 m/s



### WEAPONS

UB-75HE – unguided bomb  
high-explosive caliber 75 mm

**WEIGHT**  
2,5 kg

**DIAMETER**  
75 mm

**LENGTH**  
550 mm

**IMPACT**  
FUZE

### OPTIONAL

• HIGH EXPLOSIVE UNGUIDED BOMB



• HIGH EXPLOSIVE ANTI-TANK UNGUIDED BOMB



• HIGH EXPLOSIVE INCENDIARY UNGUIDED BOMB





## REX

### MULTIFUNCTIONAL UNMANNED COMBAT AERIAL VEHICLE

REX is able to deliver various options of bomb payloads:

- 4 x UB-75 mm-HE-FRAG (2,5 kg)
- 8 x UB-63 mm-HEAA (1 kg)
- 2 x UB-100 mm-HEI (2,5 kg)

Equipped with the Roda Lizard RB14 ground control station, Roda Serval RD 15-FHD-02 special monitor, and a modular control handle



**OPERATING RANGE**  
45+ km



**MAX TAKEOFF WEIGHT**  
16 kg



**SPEED**  
25 m/s (cruise)  
35 m/s (max)



**FLIGHT TIME**  
1,5 h



**PAYLOAD**  
10 kg



**WINGSPAN**  
2450 mm

#### TACTICAL FEATURES

- **Thermal gimbal**
  - Next vision «Dragon Eye»
  - Precise coordinate determination
  - Tracking and targeting
- **Secure video transmission**
  - 60 km Range
  - Digital signal
  - AES 256
  - EW Resistance
- **Secure radio module**
  - 120 km Range
  - Wide diversity signal
  - AES 256
  - EW Resistance

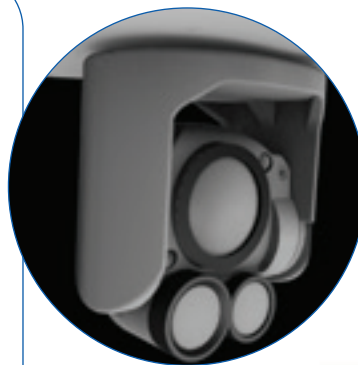

# RAM II

## UNMANNED AERIAL SYSTEM

RAM II UAS is high-precision combat loitering unmanned aerial system. It is designed to execute precise effective strikes on enemy forces and to minimize collateral damage when used in the urban area. The drone is equipped with a gyro-stabilized Full HD camera with 10x optical zoom for easy target identification



The main feature is an active visual target tracking system, that allows to lock on the target using real-time video from the onboard video camera and follow the target until the impact. RAM II UAV is powered by a quiet electric engine and has a low noise signature, anti-jamming features and encrypted data link to maximize the security of the mission



**ENGINE**  
electric



**OPERATING TEMPERATURE**  
from -20 to +40°C



**LENGTH**  
1450 mm



**CRUISING SPEED**  
70 km/h



**MAX TAKEOFF WEIGHT**  
9,8 kg



**HEIGHT**  
349 mm



**OPERATING RANGE**  
60 km



**PAYLOAD WEIGHT**  
3 kg



**WINGSPAN**  
2584 mm



**RADIO RANGE**  
30 km



**MAX FLIGHT TIME**  
40 min





## FP-1

### UNMANNED AERIAL SYSTEM

The FP-1 Unmanned Aerial System (UAS) is designed for delivering specified combat payloads (up to 50 kg) to engage ground targets with fixed topographical coordinates, at distances of up to 700 km, both day and night, in the presence of active radio interference



**OPERATING RANGE**  
up to 700 km



**MAX SPEED**  
205 km/h



**MAX PAYLOAD**  
50 kg



**FLIGHT ALTITUDE**  
2 km



**CRUISE SPEED**  
140 km/h



**WINGSPAN**  
5600 mm



**MAX FLIGHT TIME**  
up to 6 h



**MAX TAKEOFF WEIGHT**  
178 kg



**NAVIGATION SYSTEM**  
GPS/GNSS/GALILEO/BEIDU



**OPTIONAL WEAPON**  
BC-50000

**EXPLOSIVE MATERIAL MASS**  
23 kg

**EXPLOSIVE MATERIAL VOLUME**  
1585 cm<sup>3</sup>

**ASSURED FRAGMENT COUNT**  
550 pcs.

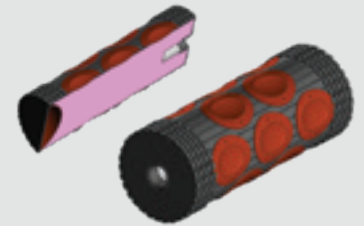

## MAGURA V5

### UNMANNED SURFACE VESSEL

The Maritime Autonomous Guard Unmanned Robotic Apparatus (MAGURA) V-type is next-generation multi-role unmanned surface vessel (USV) developed in Ukraine

The MAGURA V5 can perform multiple operations, such as surveillance, reconnaissance, patrol, search-and-rescue, mine warfare, naval fleet security, combat missions

The MAGURA V5 developed using advanced design techniques. The hydrodynamic hull and sleek profile of the V5 allow it to travel covertly with superior maneuverability

It is an affordable solution that is easy to launch from any remote location. The unmanned operation of the V5 minimizes manpower requirements for missions, reducing potential fatalities when operating in harsh conditions



 **LENGTH**  
5500 mm

 **DRAFT**  
400 mm

 **RANGE**  
450 nm (up to 800 km)

 **WIDTH**  
1500 mm

 **CRUISE SPEED**  
22 kn (41 km/h)

 **LOAD CAPACITY**  
320 kg

 **HEIGHT ABOVE WATERLINE**  
500 mm

 **BURST SPEED**  
42 kn (78 km/h)

 **CONNECTIVITY**  
mesh radio with air-based repeater or SatCom





## DESTROYED BY MAGURA V5:



## SENS-2

### OPTICAL ELECTRONIC SYSTEM

It is designed for surface visual monitoring, target detection and fire control



#### MEASURED RANGE

from 100 to 7000 m



#### MAXIMUM SPEED OF TRACKED TARGETS AT ZERO PARAMETERS

aerial — 0-700 m/s, marine — 0-60 units



### RADAR AND NAVIGATION EQUIPMENT AVAILABLE:

- Naval automated tactical data system
- Multibeam active array surveillance radar station
- Optical electronic system of the provision of helicopter take-off, homing, and SAGA ship landing
- Sarmat marine optoelectronic fire-control system of small and middle artillery caliber
- Sarmat-2 optoelectronic fire control system
- Mineral-ME multifunctional target designation radar system
- Sonar Station MG – 361 ("Centaur")
- Delta naval 2D surveillance solid-state radar
- Meganom shipborne over-the-horizon passive radar system
- Naval surveillance multi-beam active phased array radar MAARS
- Burevestnik-1M radar unit
- Positiv-E ship three-coordinate radar
- Stilet-2 fire control system with active array radar
- Kaskad integrated self-defense system for small ships
- Farad naval multifunctional active-phased array radar
- KASHTAN-3M combined laser ESM/ECM system
- SELENA-X infrared search and track system
- STILET shipboard combined optical and radar tracking system



SELENA-X

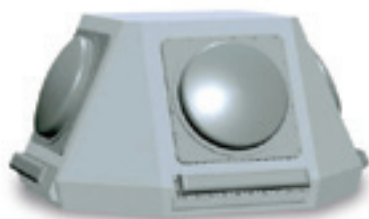

FARAD



MAARS



STILET





## SONAR COMPLEXES AND SYSTEMS

### TRONKA-MK

#### HYDROACOUSTIC STATION FOR SEARCHING OF SABOTEUR UNDERWATER SWIMMERS

The hydroacoustic station is designed for searching and detection of saboteur underwater swimmers and protects from:

- Ships of different purpose on moorage at the high sea, on the move, in stationing site
- Hydrotechnical objects in ports, harbors
- Objects of oil-producing industry located in sea basins

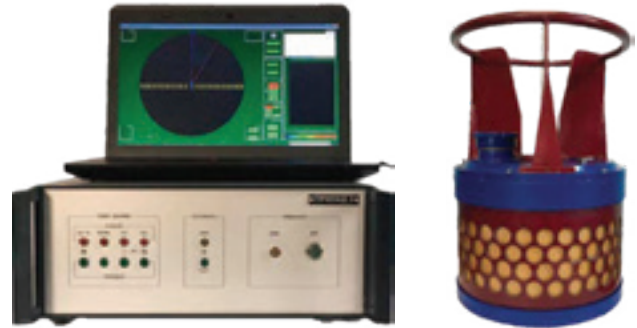

**DETECTION RANGE**  
up to 1000 m



**RANGE ACCURACY**  
1,0%



**AZIMUTH ACCURACY**  
0,8°



**ANGULAR FIELD OF VIEW**  
30°, 360° — horizontal



**AUTO TARGET TRACKING**  
up to 20



**ANTENNA IMMERSION DEPTH**  
up to 50 m

### OLYMP-3K

#### POSITIONAL HYDROACOUSTIC STATION

Positional cable sonars are designed for lighting purposes at depths of 40-200 m for intrusion detection in territorial waters or areas where critical facilities are situated. Such sonars operate in noise detecting mode allowing them to stay undetected

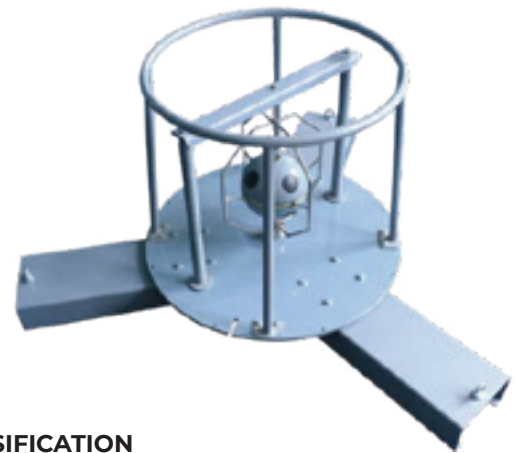

**DETECTION RANGE**  
4 km



**DEEPENING**  
40-200 m



**THE AVERAGE ERROR IN THE DETERMINATION OF BEARING**  
5°



**WEIGHT**  
40 kg



**TARGET CLASSIFICATION**  
automatic



**OBSERVATION SECTOR**  
omnidirectional



**THE SERVICE LIFE**  
24 month

## ZSU-23-4 SHILKA MODERNIZATION

### SELF-PROPELLED AIR DEFENSE SYSTEM

#### THE DEEP MODERNIZATION INCLUDES:

- Replacement of the 1RL33M radar with a multifunctional radar with a digital antenna array
- New optical location system and missile channel
- Replacement of the computing device with a digital computer system
- Integration of new combat weapon control algorithms
- Replacement of the gas turbine unit with a more economical power supply unit
- Replacement of other units



The core update is the Rokach AS digital array radar. It can work in round-the-clock mode, search and provide auto attendance. The radar confidently detects and accompanies even UAVs with an effective scattering surface of about 0.01 square meters at distances up to 7 kilometers

The new radar station with a digital array antenna can quickly identify targets both independently and according to external targets. Also, it allows to accompany several goals simultaneously that are within the range of the focus, and in the case of a single target attack, it is almost instantaneous to proceed with the preparation of firing the next target

## 2K22 TUNGUSKA MODERNIZATION

### SELF-PROPELLED AIR DEFENSE SYSTEM

Ukraine offers an upgrade for the Soviet-designed 2K22 Tunguska self-propelled air defense system. The upgrade includes life extension overhaul and replacement of the key subsystems and assemblies, including the cannon, missile launcher, and carrying chassis

A comprehensive package additionally addresses upgrades to the electronics set, ergonomics, and operator workstations, the electronic-optical system with a video processing capability





## MODERNIZATION OF AIR DEFENSE SYSTEMS

### 2K12 KVADRAT MODERNIZATION

#### SAM SYSTEM

Engagement Radar Vehicle (SURN)  
The Upgraded Surface-To-Air (SAM) System features improved performance and extended functional capabilities due to new algorithms of data processing and display, digital signal processing with software-based MTI, and automatic data read-out and processing. It offered as the upgraded follow-on to 2K12M1



### S-125M PECHORA MODERNIZATION

#### SAM SYSTEM

##### MAIN DIRECTIONS OF ACTIVITIES:

- Upgrading of C-125M Pechora AAMS to the level of C-125M2R by means of installation of upgraded 5V27D-M 1/M2 anti-aircraft guided missiles equipped with active/semi-active radar-guided homing heads;
- Equipping of antenna post as part of arming head department with the up-to-date FCR-125M2R pulse-Doppler radar and with the new Oklik radio-correction system;
- Renovation of 5P73MP launching facility and PR-14ME transportation-and-loading truck, and installation of the new up-to-date computer-aided control point (ACP), and the same for test and control equipment AKIPS-125M, the system of autonomous power supply as well as for the monitoring-and-testing station.



#### OTHER ANTI-AIRCRAFT MODERNIZATION OPTIONS:

**9K37 BUK**  
**9K33 OSA**

**IGLA-1M**  
**S-300 Family**

**S-60**  
**S-75**



2k12 KVADRAT



9k33 OSA



9k37 BUK



IGLA-1M

## SL-231 SCOUT

### LIGHT MULTIPURPOSE HELICOPTER

The SL-231 SCOUT Helicopter is a Ukrainian multipurpose light three-seater helicopter of a classic design. The helicopter is designed under AP-27 standards

It has an airframe constructed of riveted duralumin alloy, and energy-absorbing landing gears and seats. The digital cockpit is provided by two Nesis displays produced by the Slovenian company Kanardia, which specializes in the design and manufacture of avionics for ultralight aircraft and gyrocopters



**ENGINE**

Lycoming IO-379  
225 hp (168 kW)



**SPEED**

cruising – 187 km/h  
max – 209 km/h



**GROSS WEIGHT**

882 kg



**FLIGHT RANGE**

600 km



**LENGTH**

9.0 m



**EMPTY WEIGHT**

450 kg



**FLIGHT DURATION**

3.2 hours



**SERVICE CEILING**

2400 m



**SEATS**

1 pilot + 2 pass.

## 2MSB-V

### LIGHT HELICOPTER

The 2MSB-V model meets the advanced technological development of aviation and has high-performance characteristics and maneuverability. The application of the newest flight and navigation complex guarantees the safety of passengers, crew, and flights. The helicopter is designed to perform the following types of work:



**PURPOSE:**

- Military mission
- VIP transportation
- Passenger transportation
- Tourist services
- Medicine – on-request option
- Fire extinguishing – on-request option
- Surveillance on land (including in the mountains) and at sea – on-request option
- Rescue on land (including in the mountains) and at sea – on-request option
- Other (special application) – on-request option



**ENGINE**

2 x Ai-450M-B



**MAX TAKEOFF WEIGHT**

3 700 kg



**FUEL TANK**

1076 l



**PRACTICAL CEILING**

4 000 m



**MAX SPEED**

220 km/h



**CREW**

1-2



**STATIC CEILING**

1620 m



**CRUISING SPEED**

200 km/h



**PASSENGERS**

8



## HELICOPTERS

### 8MSB

#### MULTIPURPOSE HELICOPTER

The 8MSB multipurpose commercial helicopter has been designed according to a single-rotor (classic) configuration with an av tail rotor.

#### PURPOSE:

- Military mission
- Transportation of passengers;
- Transportation of cargo inside cargo/passenger compartment and utilizing external load sling system;
- Search and evacuation of casualties due to emergency;
- Emergency transportation of patients to medical providers;
- Heliborne administering medical aid;
- Fire extinguishing;
- Very important person transportation



#### ENGINE

2 x TV3-117VMA-SBMIV 4E



#### SPEED

up to 280 km/h



#### OPERATING RANGE

1030 km



#### SERVICE CEILING

7500 m



#### MAX WEIGHT OF CARGO

4000 kg



#### CREW

2-3

## HELICOPTERS OVERHAUL, MODERNIZATION

### MI-8, MI-17, MI-171, MI-24, MI-35

- Replacement of pilot's analog sighting complex with a digital sight ASP-17VPM, which significantly enhances the accuracy of application of the airborne weapons
- Installation of a Laser Reticule Shaping System, ensuring the application of unguided weapons at nighttime using Night Vision Goggles (NVG). Using of electro-optical system, sight ASP-17VPM and Laser Reticule Shaping System in complex ensures the around-the-clock application of all helicopter weapons
- Adaptation of the internal and external lights for NVG compatibility to ensure helicopter round-the-clock application
- Equipping of pilot's and operator's cockpits with GPSMAP 695/696 global positioning system, intended for determination and display of navigation parameters, helicopter current position, which ensures en-route flights taking into account the terrain digital model
- Fitting of pilot's cockpit with an optional VHF radio to ensure two-way communication between the helicopter and ground stations and other helicopters within the band of 118.000-136.975 MHz and frequency space 8.33/25 kHz
- Equipping of the helicopter with a portable ELT (emergency locator transmitter), capable to transmit SOS signals on emergency frequencies: 406,028 MHz, 121,5 MHz and 243,0 MHz
- High-level active protection of helicopter from IR guided missiles of different types (Stinger, Igla, Igla-1, R-60, R-60M, R-73, Sidewinder) is achieved by means of fitting of the optronic suppression station Adros KT-01AB as well as the chaff and flare dispenser Adros KUV 26-50 (26 mm and 50 mm in caliber)



MI-8



MI-17



MI-24



MI-35

# MIG-29 OVERHAUL AND MODERNIZATION

## MULTI-ROLE FIGHTER

### MAIN DIRECTIONS OF ACTIVITIES:

- Updating of RLPK-29 (SH104) with a view of increase of the air-target detection distance;
- Updating with a view of substituting import of component elements of L203-B station for radio-electronic warfare and Gordenia one;
- Updating of the Weapon Control System for SUV-29 with a view of using of additional types of guided arming «air-air» and «air-surface» class;
- Equipping of aircraft with up-to-date efficient system for radio-electronic warfare (REW), Optic-and- electronic Aiming System OEPS-29 and Unitary Indication System CEI-31;



# SU-27 MODERNIZATION

## AIR SUPERIORITY FIGHTER

### MAIN DIRECTIONS OF ACTIVITIES:

- Updating of RLPK-27 (SH101) with a view of increasing air target's detection distance;
- Introduction of operating modes of radar aiming system (RLPK) with conservation of existing ones;
- Improvement of reliability of main RLPK units and weapon control system as a whole;
- Using such up-to-date devices as ILC-27 and MFI-27 for indication of new operating modes;
- Providing combat use of up-to-date types of aviation guided missiles of «air-air» class;
- Realizing the additional channel of «air-surface» class with output of coordinates of radio-contrasting land targets;
- Generation of target-aiming commands for using of the increased set of devices intended for protection of exchange lines and for surface photo-mapping;
- Equipping of aircraft with the up-to-date efficient system for radio-electronic warfare (REW) manufactured in the container version;





## AIRCRAFT MODERNIZATION

### AN-26 OVERHAUL AND MODERNIZATION

#### MEDIUM MILITARY TRANSPORT AIRCRAFT

Medium military transport aircraft is equipped with a big cargo door, lowering cargo ramp, mechanization facilities for handling and is intended to transport cargoes, military equipment, personnel, injured and ill persons, as well as for air landing of personnel and military equipment



### AN-32 OVERHAUL AND MODERNIZATION

#### MILITARY TRANSPORT AIRCRAFT

Light military transport multi-purpose aircraft can be operated in various climate conditions, including hot climate (up to +50°C) and from the mountain airfields. The main aircraft's purpose is to transport cargoes over short and medium-range air routes. It can be used for carrying military personnel, aerial delivery of paratroopers, and palletized and non-palletized cargoes. Its ambulance version can be used in missions of the State Emergency Service



The aircraft has high maneuverability for flights to mountain-based airfields with difficult approach conditions

### AN-32P

#### FIRE-FIGHTING AIRCRAFT

The aircraft is designed for firefighting by draining-off the extinguishing liquids. It is also capable of delivering and airdropping the smokejumper and special equipment, fire-extinguishing means to the fire sites

When dropping 8 t of extinguishing liquid out of two tanks from an altitude up to 50 m at speed of 260 km/h, a water spot of 120-160 m long and 10-35 m wide is formed on the ground



### OTHER AIRCRAFTS OVERHAUL AND MODERNIZATION



IL-76

AN-72/74

SU-24

SU-25

## UAG-40

### AUTOMATIC GRENADE LAUNCHER

Automatic grenade launcher with 40 mm bore shoots for a distance of over 2200 meters. It is intended for firing at enemy's infantry, light-armored vehicles, and protected shelters



**CALIBER**  
40 mm



**HEIGHT**  
210 mm



**RATE OF FIRE**  
370-400 shots/min



**LENGTH**  
960 mm



**FIRING RANGE**  
40 – 1500 m



**WEIGHT (WITHOUT GRENADE)**  
17 kg

**The significant advantage of UAG-40 is its design.  
The engineering development of UAG-40 includes:**

- Friction damped bolt, which consists of cantilever springs. These springs are situated on the inner surface of the tube and interact with bolt assembly
- Three-stage longitudinal screw-thread the barrel, consisting of two parts
- Rotating knob control of trigger
- Prefabricated iron sight, which is located in the handle and is designed to make UAG-40 mobile







## UAR-10

### HIGH-PRECISION TACTICAL RIFLE

UAR -10 is a semi-automatic rifle with a rotary shutter and automation based on the removal of powder gases. A feature of the UAR-10 design is the permanent connection of the cocking handle to the shutter frame. This allows you to both pull out a jammed cartridge and carry out a manual delivery. The barrel, chromed from the inside, made of stainless steel, has a guaranteed resource of up to 7,000 shots



UAR-10 can be disassembled into two components, which allows to reduce its dimensions and ensures compactness during transportation. The barrel of the rifle is cantilever fixed, which ensures the stability of aiming. The upper part of the receiver and the forend are equipped with Picatinny-type rails for mounting sights and other accessories. To reduce the level of sound and flash during a shot, the rifle can be equipped with a silencer. It is also equipped with a MagPul PRS stock for 10 or 20 rounds with an adjustable cheek and a retractable buttplate



**CALIBER**  
.308Win / 7.62x51mm



**OVERALL LENGTH**  
940 – 1045 mm



**ACCURACY**  
<1 MOA



**BARREL LENGTH**  
16" – 20" / 406 – 508 mm



**WEIGHT**  
3,8 – 5 kg



**RATE OF FIRE**  
21 rd/min



**AIMING RANGE**  
1200 m

## UAR-15

### HIGH-PRECISION TACTICAL RIFLE

UAR-15 is a Ukrainian semi-automatic self-loading rifle with a rotary bolt and automatics based on the removal of gases produced by the Zbroyar company. It is manufactured under the license of the American AR-15 rifle. The rifle has a modular design, the upper part of the receiver and the stock have Picatinny-type guides for mounting sights and other tactical accessories.



The modular design allows for easy replacement of various components: trigger, stock, pistol grip and other attachments, thereby customizing the rifle for ease of use. The UAR-15 model uses "MidLength" or "Carbine" gas systems, which ensure smooth operation of automation. The rifle is also equipped with a regular silencer, the resource of which is 10 000 shots. The weapon is characterized by high accuracy, optimized weight (3 kg), and the ability to install sights directly on the rigid receiver



**CALIBER**  
.223 Rem / 5.56x45 mm /  
7.62x35 mm / .300 AAC / 7.62x39 mm



**BARREL LENGTH**  
10.5" – 20" (267 - 508 mm)  
Stainless



**ACCURACY**  
<1 to 2 MOA



**OVERALL LENGTH**  
810 – 1040 mm



**WEIGHT**  
3.04 – 4 kg

## VULCAN (MALYUK)

### ASSAULT RIFLE

Due to its small dimensions, the Malyuk rifle can be used in SMC tactical niche. In this role, a special type of 5.45 mm ammunition is used. This type of ammo has 500 m/s speed and can be supplied with or without a steel penetrative core



#### Advantages of Malyuk weapon-ammo complex:

- Absence of ricochets, usual for standard 5.45 mm
- Absence of over-penetration through target body or obstacle
- Substantial decrease of felt recoil, superb weapon controllability
- Ballistics match standard on actual SMC deployment ranges (50-100 m) Behind the effective range bullet becomes safe fast
- Advanced functionality with the same weight is much more effective than simply adding new heavy components
- Ergonomically designed elements were made with speed and secure deployment in mind



**FIRING RANGE**  
500 m



**AMMO CAPACITY**  
30 / 45 rounds



**AMMUNITION TYPE**  
5.45x39 mm, 5.56x45 mm, 7.62x39 mm



**WEIGHT**  
3,8 kg



**MUZZLE VELOCITY (5.45/5.56/7.62)**  
900 / 940 / 715 m/s



**LENGTH**  
712 mm



**RATE OF FIRE**  
660 rd/min



**BARREL LENGTH**  
415 mm





## 7.62x51 LMG

### LIGHT MACHINE GUN

- fully mechanical system (no thermostats)
- always under manual control of operator
  - AR weight, ergonomics, and manipulation
- integrated into DI AR mechanics (adjustability and bolt service life preservation)
- automatic safety integration
- no external components
- little to no impact on system weight and balance
- multi-role weapon system MG/light assault weapon/DMR
- optic, laser, accessory are included



**FIRING RANGE**  
2000 m



**WEAPON WEIGHT**  
8 kg



**FIRE MODE**  
Semi (closed bolt)/ full auto



**AMMO CAPACITY**  
10/20/25 box mag,  
100 drum mag



**WEAPON LENGTH**  
1098 mm



**BARREL LENGTH**  
722 mm

## Z-008 GEN III PRECISION

### HIGH PRECISION TACTICAL RIFLE

The Z-008 gen III Precision provides maximum ways of adjustments and installation of tactical equipment. Foregrip allows to install the elongated Picatinny base for mounting night sight, lights, etc. Picatinny base can stand in foregrip at an angle of 45 degrees. Bipods can be placed far ahead. Designed for use with a day sight and backup collimator simultaneously. Sniper Magpul stock has a wide range of adjustments

The folding stock is comfortable to carry. The shooter will no doubt be pleased with the pistol grip, with emphasis. Typical accuracy sub 1/3 MOA



### 3 BARREL LENGTH TYPE

(Lothar Walther or Shilen barrels)

up to 27"	Overall up to 50"
up to 30"	Overall up to 52"
up to 32"	Overall up to 54"



**FLUTED BARREL**  
Muzzle thread cap



**FULLY ADJUSTABLE JEWELL TRIGGER**  
Suppressor



**ADDITIONAL PICATINNY RAIL**  
Folding stock



**WEIGHT**  
appr. 6.5 kg



**SINGLE SHORT RECEIVER**  
Additional barrel



**AMMUNITION TYPE**  
762x51 mm NATO

## BTR-3E1 / BTR 4 / BTR 80 / BMP 1

INTEGRATED CREW TRAINING SIMULATOR

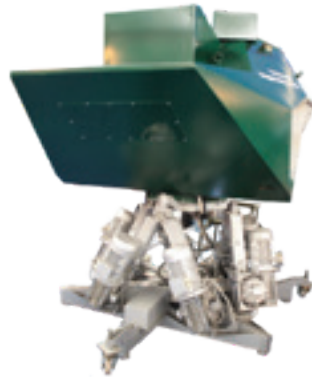

## AVIATION

INTEGRATED CREW TRAINING SIMULATOR



## ATGM

INTEGRATED CREW TRAINING SIMULATOR





## SIMULATORS

### UNITS

#### UNIVERSAL TRAINING SYSTEM

UNITS is a universal training system for conducting fire training for soldiers according to the methodology of the Ministry of Defense of Ukraine

The mobile UNITS system allows for training in any facilities, ensuring the safety of personnel. If necessary, the system can easily be moved to another location. Training can be conducted 24/7 and with any intensity

The UNITS kit may include various types of weapons, including **AT-4, NLAW, Javelin, and Stinger**. The simulator has full-size models of weapons that are identical to real weapons. This allows soldiers to thoroughly study the weapon and train muscle memory, which will help them effectively perform combat tasks



#### SYSTEM MODULES



##### SMALL ARMS

- PM
- Fort
- AK-74
- PKK
- PKM
- SVD
- AR-15



##### RENADE LAUNCHERS

- GP-25
- LNG-9
- AGS-17
- RPG-7
- RPG-22
- RPG-26
- RPV
- AT-4



##### MANPADS

- NLAW
- Stinger FIM-92
- Javelin FGM-148
- Strila 9K32
- Iгла 9k310

#### THE PURPOSE OF THE SYSTEM

The system's purpose is to practice proper stance, breathing, weapon handling, aiming, and smooth trigger pull during combat maneuvers

Practice of using firearms in various situations with the use of video footage

The system allows for the practice of instinctive shooting skills without aiming in conditions of limited visibility and time

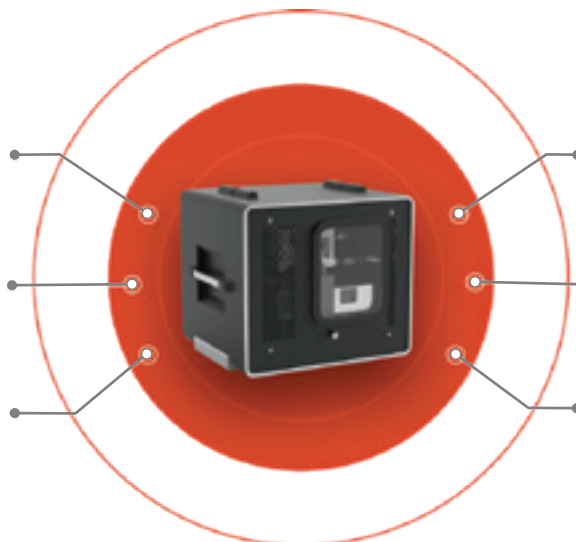

The system facilitates processing, maintenance, and improvement of marksmanship skills in static shooting

Advanced training in fire control and shooting at moving targets

Conducting individual training shooting and competitions between several participants







**STATE FOREIGN TRADE ENTERPRISE  
SPETSTECHNOEXPORT**

7, Stepana Bandery Avenue, Kyiv, 04073, Ukraine  
Tel.: +38 (044) 568 50 70  
Fax: +38 (044) 568 53 48  
E-mail: [office@ste.com.ua](mailto:office@ste.com.ua)  
[www.ste.com.ua](http://www.ste.com.ua)



## TABLE OF CONTENTS

# TABLE OF CONTENTS